



This is a digital copy of a book that was preserved for generations on library shelves before it was carefully scanned by Google as part of a project to make the world's books discoverable online.

It has survived long enough for the copyright to expire and the book to enter the public domain. A public domain book is one that was never subject to copyright or whose legal copyright term has expired. Whether a book is in the public domain may vary country to country. Public domain books are our gateways to the past, representing a wealth of history, culture and knowledge that's often difficult to discover.

Marks, notations and other marginalia present in the original volume will appear in this file - a reminder of this book's long journey from the publisher to a library and finally to you.

Usage guidelines

Google is proud to partner with libraries to digitize public domain materials and make them widely accessible. Public domain books belong to the public and we are merely their custodians. Nevertheless, this work is expensive, so in order to keep providing this resource, we have taken steps to prevent abuse by commercial parties, including placing technical restrictions on automated querying.

We also ask that you:

- + *Make non-commercial use of the files* We designed Google Book Search for use by individuals, and we request that you use these files for personal, non-commercial purposes.
- + *Refrain from automated querying* Do not send automated queries of any sort to Google's system: If you are conducting research on machine translation, optical character recognition or other areas where access to a large amount of text is helpful, please contact us. We encourage the use of public domain materials for these purposes and may be able to help.
- + *Maintain attribution* The Google "watermark" you see on each file is essential for informing people about this project and helping them find additional materials through Google Book Search. Please do not remove it.
- + *Keep it legal* Whatever your use, remember that you are responsible for ensuring that what you are doing is legal. Do not assume that just because we believe a book is in the public domain for users in the United States, that the work is also in the public domain for users in other countries. Whether a book is still in copyright varies from country to country, and we can't offer guidance on whether any specific use of any specific book is allowed. Please do not assume that a book's appearance in Google Book Search means it can be used in any manner anywhere in the world. Copyright infringement liability can be quite severe.

About Google Book Search

Google's mission is to organize the world's information and to make it universally accessible and useful. Google Book Search helps readers discover the world's books while helping authors and publishers reach new audiences. You can search through the full text of this book on the web at <http://books.google.com/>

Educ T 6719, 15, 435

**Gift of The People of the United States
Through the Victory Book Campaign
(A. L. A. — A. R. C. — U. S. O.)
To the Armed Forces and Merchant Marine**



3 2044 102 785 896







FOREST INTERIOR. SEQUOIA NATIONAL PARK, CALIFORNIA

ESSENTIALS OF WOODWORKING

A TEXTBOOK FOR SCHOOLS

BY

IRA SAMUEL GRIFFITH, A. B.

CHAIRMAN OF

THE DEPARTMENT OF MANUAL ARTS, UNIVERSITY OF MISSOURI.

AUTHOR OF "CORRELATED COURSES IN WOODWORK AND MECHANICAL DRAWING", "PROJECTS IN BEGINNING WOODWORK AND MECHANICAL DRAWING" AND "ADVANCED PROJECTS IN WOODWORK".



THE MANUAL ARTS PRESS

PEORIA, ILLINOIS

1915

EdueT 6719.15.435

✓



Copyright, 1908
Ira Samuel Griffith
Eleventh Edition, 1915

PREFACE.

An experience, somewhat extended, in teaching academic branches of learning as well as woodworking, has convinced the author that the most effective teaching of woodworking can be accomplished only when its content is made a subject of as diligent study as is that of the other and older branches. Such a study necessitates the use, by the student, of a textbook.

The selection of a suitable text is made difficult because of the fact that tool processes are usually treated in connection either with models or exercises. It is hardly to be expected that any one set of models or of exercises, tho they may be of very great value, will fill the needs of varying local school conditions. The production of a textbook which shall deal with tool processes in a general way without reference to any particular set of models or exercises is the author's aim. It is believed that such a text will prove suitable wherever the essentials of woodworking shall be taught, whether in grammar, high school or college, and whatever the system of instruction.

A few words as to the manner of using the text seem advisable. It is not expected that the book will be studied chapter by chapter, consecutively, as are the elementary texts in mathematics or science. Rather, it is to be studied topically. To illustrate: A class is to make a model, project, exercise, or whatever we may choose to call it,

which will require a knowledge of certain tools and the manner of using them. At a period previous to their intended use the numbers of the sections of the text relating to these tools and their uses, or the page numbers, should be given the student. Previous to the period in which these tools are to be used he should be required to study the sections so marked. The recitation upon the assigned text should take place at the beginning of the period following that of the assignment, and may be conducted in a manner quite similar to that of academic branches.

The "demonstration" may be given at the time the assignment is made or it may be given in connection with the recitation or at its close.

If as thoro a knowledge of the matter studied is insisted upon in the recitation as is insisted upon in the academic classroom, there need be but little excuse for ignorance on the part of the pupil when he begins his work or at any subsequent time.

Acknowledgment is due the Department of Forestry, Washington, D. C., for the use of material contained in the chapter on Woods and for the prints from which many of the half-tones relating to forestry were produced.

INTRODUCTION.

CARE OF TOOLS AND BENCH.

It is important that a beginner should become impressed with the necessity of keeping his tools in the best condition. Good results can be obtained only when tools are kept sharp and clean, and used only for the purposes for which they are made. Tools properly sharpened and properly used permit one to work easily as well as accurately. When it becomes necessary for the worker to use undue strength because of the dullness of his tools, "troubles" begin to accumulate and the "pleasure of doing" is soon changed to despair.

Orderliness and carefulness, with knowledge and patience, are sure to bring good results; just as a lack of them will bring failure.

The bench top must not be marked with pencil or scratched unnecessarily. Chisel boards are to protect the top from any accidental cuts and should always be used for that purpose. Bench tops that are scraped and shelaced or oiled every other year ought to remain in as good condition as when new except for the few accidental marks too deep to remove, which the thoughtless boy may have inflicted.

Good workers take pride in keeping their benches in good order. Tools that are not in immediate use should

be placed in their racks that they may not be injured or cause injury to the worker. At the close of the period the bright parts of tools that have come in contact with perspiring hands should be wiped off with oily waste kept for that purpose. All tools should then be put away in their proper places and the top of the bench brushed clean.

The beginner should also understand that, important as are the results he may be able to produce in wood, more serious results are being produced in himself in the habits he is forming. Carefulness, neatness, accuracy, ability to economize in time and material, ability to "think" and "to do" because of the thinking, honesty, orderliness—these are some of the more important results that are oftentimes overlooked.

CONTENTS.

INTRODUCTION.

Care of tools and bench	3
-----------------------------------	---

PART ONE.

TOOLS AND ELEMENTARY PROCESSES.

CHAPTER I.—Laying-out Tools; Their Uses	9
---	---

1. The rule; 2. The try-square; 3. The framing square; 4. The bevel; 5. The marking gage; 6. The pencil gage; 7. Slitting gage; 8. The mortise gage; 9. The dividers; 10. Pencil and knife.

CHAPTER II.—Saws	21
----------------------------	----

11. Saws; 12. The crosscut saw; 13. The rip-saw; 14. The back-saw; 15. The turning saw; 16. The compass saw; 17. Saw filing.

CHAPTER III.—Planes	29
-------------------------------	----

18. Planes; Setting the blade; 19. Adjustment of the iron; 20. The jack-plane; 21. The smooth-plane; 22. The jointer; 23. The block-plane; 24. The wooden plane; 25. Woodworking terms; face side, face edge; 26. General discussion of planing; 27. Planing first surface true; 28. Planing first edge square with face side; 29. Finishing the second edge; 30. Finishing the second side; 31. Planing the first end square; 32. Finishing the second end; 33. End planing with the shooting board; 34. Rules for planing to dimensions; 35. Planing a chamfer.

- CHAPTER IV.—Boring Tools; Boring..... 47
 36. Brace or bitstock; 37. Center bit; 38. The auger bit; 39. The drill bit; The gimlet bit; 40. Counter-sink bit; 41. The screwdriver bit; 42. The brad-awl; 43. Positions while boring; 44. Thru boring; 45. Boring to depth.
- CHAPTER V.—Chisels and Chiseling..... 53
 46. Chisels; 47. Horizontal paring across the grain; 48. Vertical paring; 49. Oblique and curved line paring; 50. Paring chamfers; 51. The firmer gouge; 52. Grinding beveled edge tools; 53. Whetting beveled edge tools; 54. Oilstones; 55. Sharpening the chisel; 56. Sharpening plane-irons; 57. To tell whether a tool is sharp or not.
- CHAPTER VI.—Form Work; Modeling..... 65
 58. Making a cylinder; 59. The spokeshave; 60. Making curved edges; 61. Modeling.
- CHAPTER VII.—1. Laying Out Duplicate Parts; 2. Scraping and Sandpapering; 3. Fastening Parts..... 70
 62. Laying out duplicate parts; 63. Scraping; 64. Sandpapering; 65. Hammers; 66. Nails; 67. Nailing; 68. Nailset; 69. Withdrawing nails; 70. The screwdriver; 71. Screws; 72. Fastening with screws; 73. Glue; 74. Clamps; 75. Gluing.

PART TWO.

SIMPLE JOINERY.

- CHAPTER VIII.—Type Forms..... 84
 76. Joinery; 77. General directions for joinery; 78. Dado; 79. Directions for dado; 80. Cross-lap joint;

81. Directions for cross-lap joint, *first method*; 82. Directions for cross-lap joint, *second method*; 83. Glue joint; 84. Directions for glue joint; 85. Doweling; 86. Directions for doweling; 87. Keyed tenon-and-mortise; 88. Directions for key; 89. Directions for tenon; 90. Directions for mortise; 91. Directions for mortise in the tenon; 92. Blind mortise-and-tenon; 93. Directions for tenon; 94. Directions for laying out mortise; 95. Directions for cutting mortise, *first method*; 96. Directions for cutting mortise, *second method*; 97. Miter joint; 98. Directions for miter joint; 99. Dovetail joint; 100. Directions for dovetail joint.

CHAPTER IX.—Elementary Cabinet Work. 105

101. Combination plane; 102. Drawer construction; 103. Directions for rabbeted corner; 104. Directions for dovetail corner; 105. Directions for drawer; 106. Paneling; 107. Cutting grooves; 108. Haunched mortise-and-tenon; 109. Rabbeting; 110. Fitting a door; 111. Hinging a door; 112. Locks.

PART THREE.

WOOD AND WOOD FINISHING.

CHAPTER X.—Wood. 116

113. Structure; 114. Growth; 115. Respiration and transpiration; 116. Moisture; 117. Shrinkage; 118. Weight; 119. Other properties; 120. Grain.

CHAPTER XI.—Lumbering and Milling. 126

121. Lumbering; 122. Milling; 123. Quarter sawing; 124. Waste; 125. Lumber transportation; 126. Seasoning; 127. Lumber terms and measurements.

CHAPTER XII.—Common Woods.....	138
128. Classification. <i>Coniferous woods</i> : 129. Cedar; 130. Cypress; 131. Pine; 132. Spruce. <i>Broad-leaved woods</i> : 133. Ash; 134. Basswood; 135. Birch; 136. Butternut; 137. Cherry; 138. Chestnut; 139. Elm; 140. Gum; 141. Hickory; 142. Maple; 143. Oak; 144. Sycamore; 145. Tulip wood; 146. Walnut.	
CHAPTER XIII.—Wood Finishing.....	150
147. Wood finishes; 148. Brushes; 149. General directions for using brush; 150. Fillers; 151. Filling with paste filler; 152. Stains; 153. Waxing; 154. Varnishes; 155. Shellac; 156. Shellac finishes; 157. Oil or copal varnishes; 158. Flowing copal varnish; 159. Typical finishes for coarse-grained woods; 160. Patching; 161. Painting.	
APPENDIX I.—Additional Joints.....	164
APPENDIX II.—Wood Finishing Recipes.....	171
1. Wax; 2. Water stains; 3. Oil stains; 4. Spirit stains.	
APPENDIX III.—Working Drawings.....	173
1. Instruments; 2. Conventions; 3. Projection and relation of views; 4. Letters and figures; 5. Constructions; 6. Order of procedure.	
INDEX.....	183

PART ONE.
TOOLS AND ELEMENTARY PROCESSES.

CHAPTER I.

LAYING-OUT TOOLS—THEIR USES.

1. **The Rule.**—The foot is used as a unit of measurement in woodwork. The rule ordinarily used is called a two-foot rule because of its length. Such rules are hinged so as to fold once or twice and are usually made of

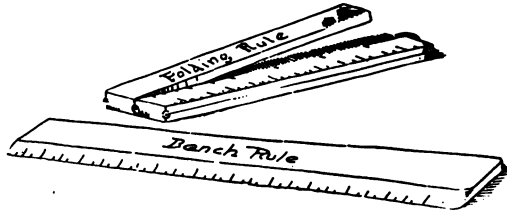

FIG. 1.

boxwood or maple. The divisions along the outer edges, the edges opposite the center hinge, are inches, halves, fourths, eighths, and on one side sixteenths also. Fig. 1.

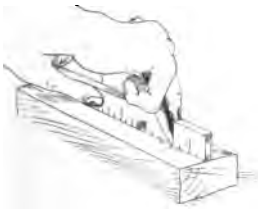

FIG. 2.

the wood at the same time. Fig. 2.

Whenever there are several measurements to be made along a straight line, the rule should not be raised until

all are made, for with each placing of the rule errors are likely to occur.

The rule is used to find the middle of an edge or surface by placing it across the piece so that the distances

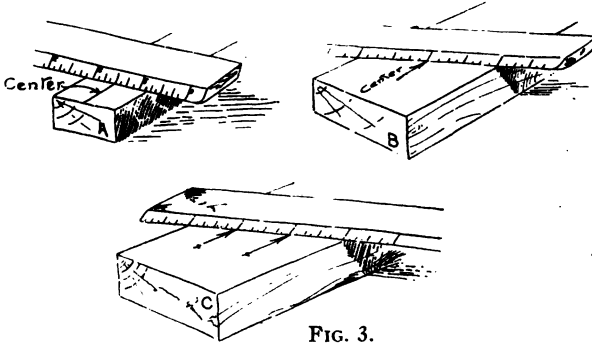

FIG. 3.

from the edges of the piece to corresponding inch, or fractional marks, shall be the same, Fig. 3A, the middle of the piece being at a point midway between the marks selected.

Fig. 3B illustrates a second method of finding the middle of a piece. Lay the rule across the piece at an angle such that two of the unit marks shall rest each upon an arris. The middle of the piece will then be at that unit mark which is midway between these.

If it is desired to divide a piece into more than two parts lay the rule across the piece at such an angle as will bring two of its unit marks each upon an arris with the required number of divisions between. Fig. 3C shows a piece divided into three equal parts.

2. The Try-square.—The try-square may be made entirely of iron or steel or it may have a head of wood, called the beam, and a blade of steel. The blade is graduated into inches and fractions of an inch. As all try-

squares are liable to be injured by rough usage, care should be taken not to let them drop on the bench or floor, nor should they ever be used for prying or pounding. Fig. 4.

The try-square is used for three purposes: First, to act as a guide for the pencil or knife point in laying out lines

across the grain at right angles to an edge or surface; second, to test an edge or end to see whether it is square to an adjoining surface or edge; third, to test a piece of work to see whether it is of the same width or thickness thruout its entire length.

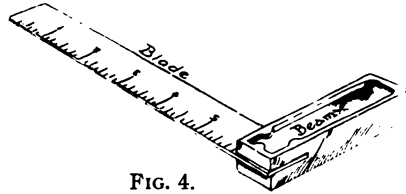

FIG. 4.

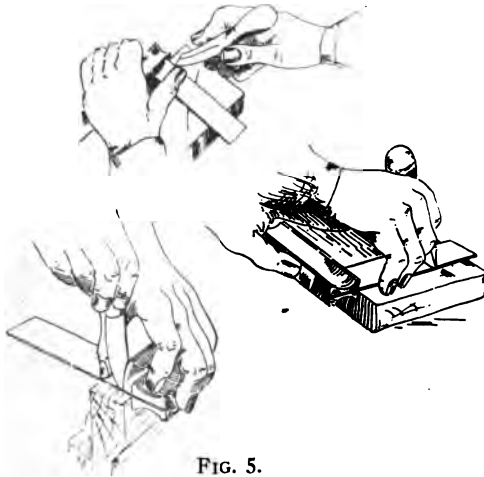

FIG. 5.

Fig. 5 shows the various positions assumed in lining across a piece. The beam should be held firmly against either the face side or the face edge.

The face side of a piece is the broad surface which is first made true. The face edge is the first edge which is made square to the face side and straight. These two surfaces are usually marked in some way so that they

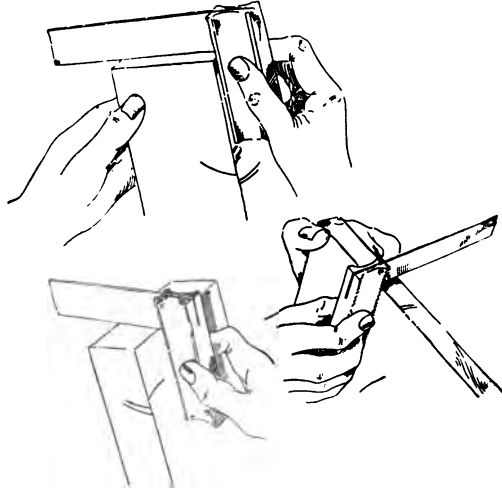

FIG. 6.

may be distinguished from the other surfaces. Their use is fully explained in Chapter III.

If the beam projects beyond the end of the wood, it should be reversed. The knife should be inclined forward and away from the blade of the try-square slightly. A light, firm line should be made the first time across the piece.

In testing edges or ends for squareness, the beam should be held, as in lining, firmly either against the face side or the face edge. Fig. 6. Care should be taken to test the extreme ends of the piece. Also test at a sufficient number of points to show fully the condition of the

edge. Sliding the try-square along the edge is not objectionable if the blade be held lightly on the surface.

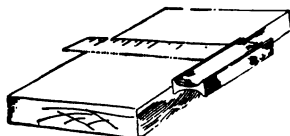

FIG. 7.

Under no circumstances should the try-square be used to scrape the wood.

In testing a piece to see whether it is of the same width or thickness thruout its entire length, place the blade across the surface to be tested, holding the beam lightly against the face side or face edge, slide the try-square along the piece with the eye fixed upon the graduations at the outer edge. Fig. 7.

3. The Framing Square.—Large squares of one piece of steel, called framing squares, are used by carpenters for large and rough work. The long arm is called

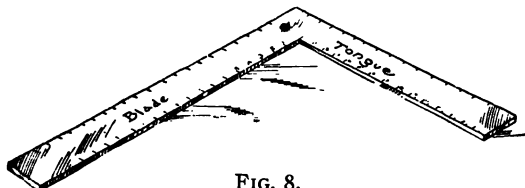

FIG. 8.

the blade and the short one the tongue. Fig. 8. In addition to the divisions into inches and fractions of an inch, there is on the blade a board measure table and on the tongue a brace or rafter measure table. This square will be found convenient when "cutting up" stock, also for testing corners of large pieces of furniture and for setting the bevel to various angles.

4. The Bevel.—The bevel differs from the try-square in having a movable blade. Fig. 9. This blade may be set at any desired angle from 0 to 180 degrees. The manner

of using the bevel is similar to that of the try-square. When adjusting, the blade should be just loose enough to move upon the application of slight pressure.

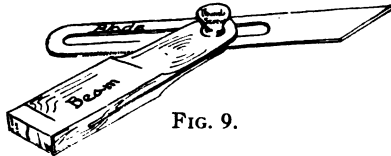
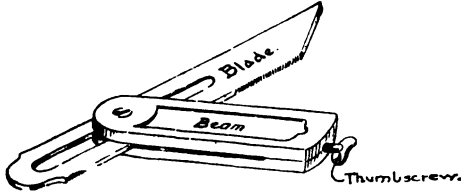

FIG. 9.

There are various ways of setting the bevel to the required angle. Should the triangle used in mechanical drawing be available, angles of 30 degrees, 45 degrees and 60 degrees are easily obtained by ad-

justing the bevel to the sides of the required angle.

To set the bevel to 45 degrees by means of the framing square, hold the beam against one of the arms, Fig. 10, and move the

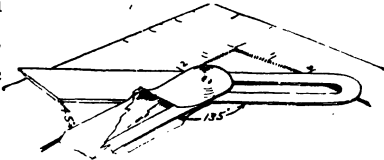

FIG. 10.

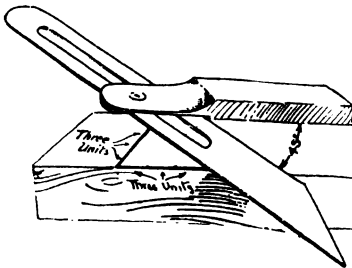

FIG. 11.

blade so that it shall pass through corresponding points on both blade and tongue. Fig. 11 illustrates a method in which no other tools are needed. A

line is squared across a board having a straight edge. Equal distances are measured from the point at which the

line cuts the edge, the blade then being made to pass thru these points while the beam is held tightly against the edge.

For angles of 30 degrees and 60 degrees, square a knife line at right angles to an edge. Fig. 12. Measure from the edge, along this line, or from this line along the edge any given distance. Take twice this distance upon the blade of the bevel and adjust so that a right triangle is formed in which the length of the longest side shall be twice that of the shortest.

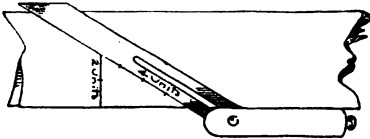
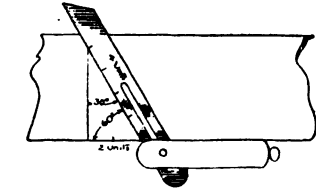

FIG. 12.

5. The Marking Gage.—The gage is used for laying out lines along the grain of the wood. It consists of a beam, Fig. 13, head, thumbscrew, and marking point

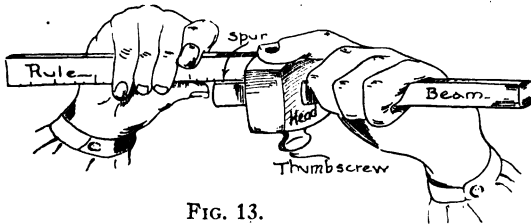

FIG. 13.

or spur. The spur should be sharpened to a knife point with a file so that it may make a fine smooth line. It should project far enough below the beam so that the beam may be rolled forward in such a way as to bring the

spur into the board at a slight angle, when properly marking. It should extend not less than an eighth of an inch and in most cases three-sixteenths of an inch.

The graduations on the beam are seldom reliable. It is safer to set the gage with the rule by measuring the distance from the spur to the gage block. This is done by holding the gage bottom side up in the left hand. With the right place the end of the rule against the head. Fig. 13. After the screw has been tightened, apply the rule again to make sure of the correctness of the setting.

To gage the line, take the tool in the right hand, three fingers grasping the beam, the first finger encircling the head, if the work is narrow, and the thumb back, or nearly back, of the spur. Fig. 14. The head should be kept

against one or the other of the faces. Begin at the end of the piece which is towards you, hold the block firmly against the piece, roll the beam forward until the spur barely touches the

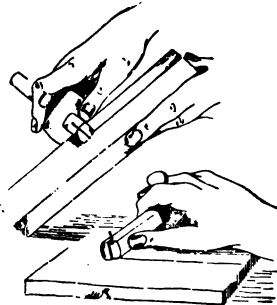

FIG. 14.

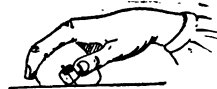

FIG. 15.

surface, and make a very light line. Fig. 15 illustrates the manner of raising the spur from the wood by raising the wrist during the backward stroke. It will be found convenient to hold the piece against the bench stop. This steadies the piece and permits the worker to see how deep the spur is cutting and whether the head is against the face properly. Avoid deep lines; they are inaccurate

even if straight and always cause trouble in the making unless the grain of the wood is perfectly straight.

6. The Pencil Gage.—There are occasions when a pencil gage marks with sufficient accuracy and is more suitable because its point does not cut the wood, as in gaging for a bevel. A hole bored thru the beam near



FIG. 16.

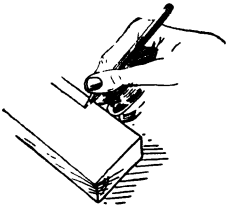

FIG. 17.



Slitting Gage



Mortise Gage

Panel Gage
For wide boards

FIG. 18.

one end, just large enough to receive a pencil snugly, will suffice. Fig. 16.

Fig 17 illustrates a method frequently used by carpenters. The fingers act as a gage head.

7. Slitting Gage.—A slitting gage is one in which the spur is sharp and strong, and will cut thru soft lumber as thick as one-quarter of an inch. The boards are cut from each side and considerable pressure is required. Sometimes a handle like that of the plane is fastened to the beam near the knife or spur. Fig. 18.

8. **The Mortise Gage.**—Fig. 18 also shows a mortise gage used in advanced work. It has two spurs, one of them adjusted by means of the screw at the end of the beam to any desired distance from the stationary one, so that the two sides of a mortise or tenon can be marked at once.

9. **The Dividers.**—Dividers, Fig. 19, are used (1) in describing circles, (2) in dividing a given space into a given number of parts, and

(3) in marking one member which is to be fitted to another irregular member. Fig. 20 shows the manner of setting the dividers.

The thumbscrew should be released so that the legs may be moved without much effort. When the approximate setting has been secur-

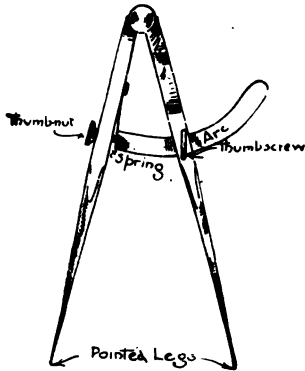

FIG. 19.

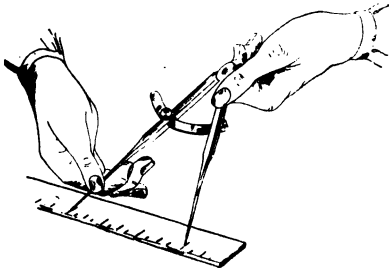

FIG. 20.

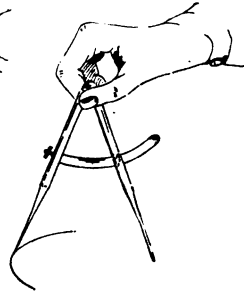

FIG. 21.

ed, use the thumb-nut for adjusting to more accurate measurement. In describing circles, the dividers should be held as in Fig. 21 and swung to the right or left as

is convenient. They should be leaned forward slightly and an effort made to secure a sharp, light line. For most work the two legs may be sharpened to points. Sometimes one is sharpened like a knife point.

10. Pencil and Knife.—Pencil lines may be used in getting out stock from rough material and in laying out work on rough surfaces where a knife line would not be visible. Pencil lines should be carefully made, however. The pencil may be used also in marking bevels, curves, and in other places where the knife or gage mark would be injurious. Otherwise, the knife and gage should be used. Pencil lines are easiest removed from wood by means of the eraser.

In laying out rough stock, if the first edge is sufficiently straight, it is

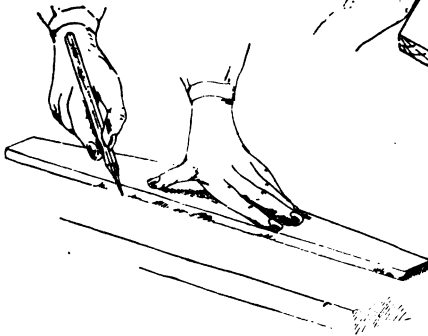

FIG. 23.

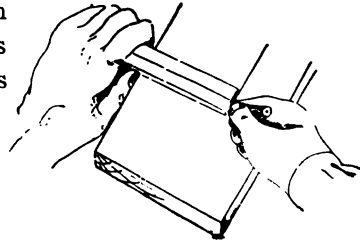

FIG. 22.

usual to thumb-gage for width. This is done by holding the pencil at the end of the rule and using the thumb of the left

hand as the gage-head, drawing the whole towards you with the rule acting as gage-beam. Fig. 22.

A straight-edge, a board with a straight edge, is often used in marking out. Mark off the length of the piece

of wood required. Mark off the breadth at the end of the board, also mark it near what is to be the other end of the piece. Place the straight-edge on these two marks and draw the line. Fig. 23. The try-square should be used to mark across the grain. Rip-saw first, then crosscut, leaving on the board all but just what is wanted for present use.

CHAPTER II.

SAWS.

11. **Saws.**—Saws which are used in cutting across the grain are called crosscut; those which are used in cutting parallel to the grain are called rip-saws. Fig. 24. Upon the blade of a saw, near the handle, will be found a num-

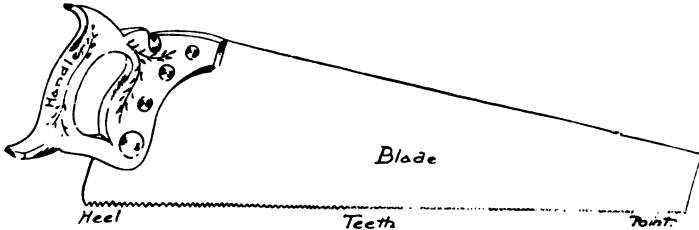

FIG. 24.

ber. This represents the number of points to the inch. Points should not be confused with teeth, for there is always one more point per inch than there are teeth.

To prevent the sides of a cut, or kerf, from binding the saw, the teeth are bent alternately from side to side, that the opening may be wider than the blade is thick. The saw teeth are then said to have "set." To do good work, a saw should have no more set than is necessary to allow free movement. Fig. 25. Damp, spongy lumber will require considerable set, while well-seasoned lumber necessitates but little.

The rake, or pitch of the teeth of a saw, is the degree of slant which the cutting edges possess with reference

to an imaginary line passing thru the points of the teeth. Fig. 25. The amount of pitch given will depend

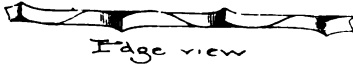

FIG. 25.

upon the use to which the saw is to be put—whether for ripping or cross-cutting, and somewhat upon the hardness or softness of the wood to be cut.

Fig. 26 shows the saw in proper position. It should be held in the right hand with the left hand grasping the board, the thumb of the left hand acting as a guide in the beginning. The thumb should

be held firmly on the board and the blade of the saw should be pressed lightly against it. The cutting edge of the saw should be held at an angle of about forty-five degrees to the board and should be started on a backward stroke. The first few strokes should be short ones, increasing gradually in length.

If the tool is sharp, but little pressure will ever be required and, in starting, the tool must be held up so that its weight shall come upon the wood gradually.

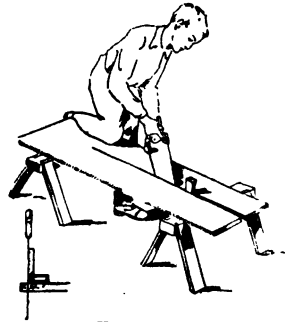

FIG. 26.

Saws can be guided better if the index finger of the right hand is allowed to extend along the side of the

handle. Test occasionally, sighting down the saw blade to see that the sides of the saw are at right angles to the surface of the board. A try-square may be used by the beginner, as shown in Fig. 26.

If the saw does not follow the direction of the line, the blade should be slightly twisted, as the sawing proceeds, in the direction it ought to take. This must be carefully done so as not to cause the blade to bind and kink.

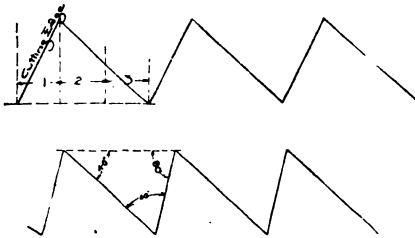

FIG. 27.

In sawing a board which has been fastened in the vise, the most convenient position is obtained by sawing at right angles to the surface. Unless the saw has considerable

set, difficulty will be experienced in changing the direction of the cutting should this be necessary. This may be overcome by lowering the handle so that the cutting edge shall make the same angle with the board as when the board rests on trestles.

When making a long cut, should the kerf bind, a wedge may be inserted as shown in Fig. 26.

All saws will work easier and will be found less likely to rust if their sides are rubbed occasionally with an oily rag or a piece of tallow.

12. The Crosscut Saw.—Fig. 25 shows the teeth of a crosscut saw. This saw is filed so that the cutting edges are on the sides of the teeth. Every tooth is sharp-

ened to a point, one on the right side, the next on the left, giving two parallel lines of sharp points with a V-shaped groove between.

The pitch given the teeth of a crosscut saw will vary with the hardness or softness of the wood which is to be cut. For all-around use the amount of slant is about one-third of the whole tooth. Fig. 27.

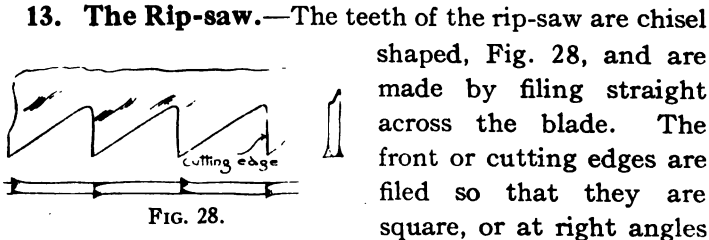

14. The Back-saw.—The back-saw, or tenon-saw as it is often called, has a thin blade strengthened by a heavy steel back piece. It is used upon work requiring delicate, accurate cutting. Fig. 29.

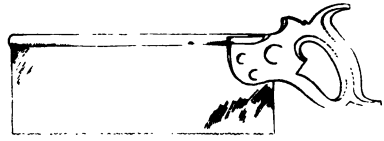

FIG. 29.

Fig. 30 shows the shape of the teeth, which differ slightly from those of the crosscut. These teeth are suitable for both cross-cutting and fine ripping. But little set is given the teeth of the back-saw.



FIG. 30.

In using this saw, Fig. 31, hold the work firmly against the stop of the benchhook with the left hand, guiding the

saw with the forefinger or thumb placed against the blade just above the teeth. Hold the handle end of the saw highest. Begin at the farthest corner, using short, easy strokes. Gradually lower the handle to a horizontal position, meanwhile increasing the number of teeth used, but continuing the slow, regular strokes.

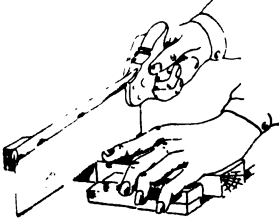

FIG. 31.

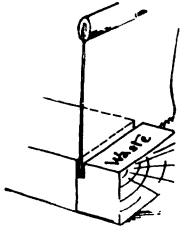

FIG. 32.

In accurate cutting, Fig. 32, where no paring or block-planing is to be done, the saw teeth should cut just by the line, with the kerf in the waste, but with no wood between the

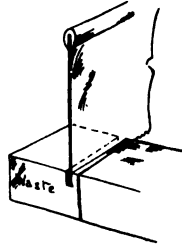

FIG. 33.

line and the kerf. To allow for paring or block-planing, saw about one-sixteenth of an inch in the waste. Fig. 33.

When ripping, place the piece in the vise and begin sawing as indicated in Fig. 34. Place the saw so that just the whole of its thickness is in what is to become waste wood. Begin sawing as was done in cross-cutting. Gradually lower the handle, while sawing, until most is being cut from the side nearest you. Fig. 35. Reverse the wood several times, working down one side then the other until the

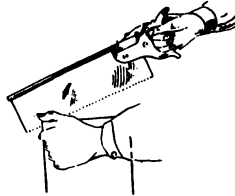

FIG. 34.

cross lines are reached. Fig. 36 illustrates the result of good and bad sawing.

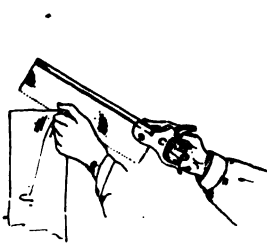

FIG. 35.

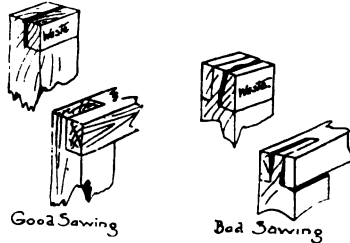

FIG. 36.

15. The Turning Saw.—The turning or bow-saw is used for cutting along curved lines. Fig. 37 illustrates the manner of holding this saw. The sides of the blade must be held at right angles to the surface of the wood. Either or both handles may be turned, thus turning the blade with reference to the frame. Avoid turning the

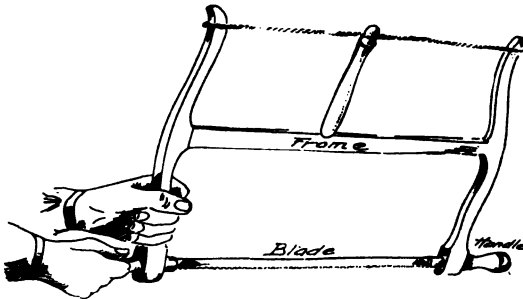

FIG. 37.

blade, however, as much as possible, and see that the blade is not twisted by turning one handle more than the other.

This saw may be used for cutting enclosed curves by boring a hole, releasing one end of the blade and inserting it thru this hole then replacing it in the saw frame.

As the cut of the turning saw is not very smooth, it is advisable to leave about one-sixteenth of an inch between the kerf and the line, to be removed later with the spoke-shave.

16. The Compass Saw.—The compass saw, Fig. 38, is better suited for inside curve sawing. Its use requires a steady hand, else the thin blade will buckle and break.

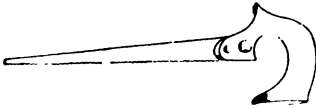

FIG. 38.

17. Saw Filing.—Learning to sharpen a saw is a difficult thing—so difficult that it is not considered within the province of a book on elementary woodworking to treat of it. One who uses saws, ought, however, to know the steps which are taken to put a saw in order.

The teeth are first set. Fig. 39 shows a common form of saw-set in position. Beginning at one end of the saw, every other tooth is bent

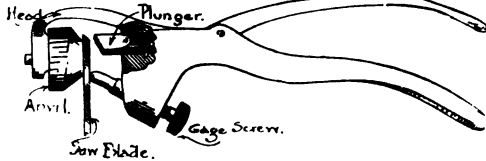

FIG. 39.

outward by means of this instrument. The saw is then reversed and the remaining teeth are similarly treated.

As these saw-sets are adjustable, the teeth may be bent much or little as the work to be done demands.

Second, the teeth are jointed. A flat file is run lengthwise over them the full length of the saw so that none of the teeth may project more than others. Fig. 40 shows a flat file in position for jointing. This block keeps the surface of the file at right angles to the blade of the saw.

Third, the saws are filed, a three-cornered file being used for this purpose. The kind of saw determines the

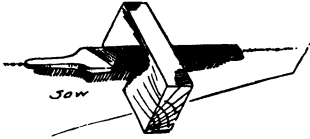

FIG. 40.

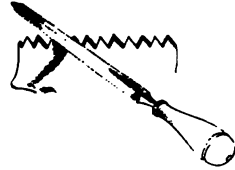

FIG. 41.

angle or angles at which the file is held with reference to the saw blade. Fig. 41 illustrates the position when filing the crosscut and Fig. 42 the rip-saw.



FIG. 42.



FIG. 43.

Fourth, the teeth are side jointed by laying the saw flat upon the bench and rubbing an oilstone over each side lightly, once. Fig. 43. This is to even the sides of the teeth that the kerf may be smoothly cut.

CHAPTER III.

PLANES.

18. Planes; Setting the Blade.—A standard plane of the present time is shown in Fig. 44. The bottom of this plane is of iron. Fig. 45 shows a plane with the same ad-

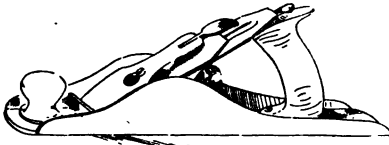

FIG. 44.

justments in which the bottom is of wood. Planes are made in different sizes. As certain lengths are more suitable for certain kinds

of work, they have been given distinguishing names such as jack-plane, smooth-plane, fore-plane, jointer. Fig. 44 shows the jack-plane.

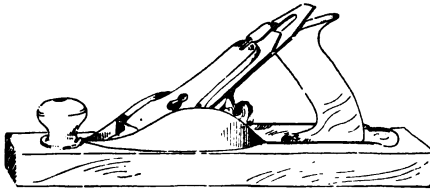

FIG. 45.

The two irons of the plane, the plane-iron or plane-bit, and the cap-iron are fastened together by means of a stout screw. Fig 46.

This cap-iron serves a double purpose. First: It stiffens the plane-iron; second, it serves to bend and break the shaving, and thereby prevent a splitting action in front

of the cutting edge. This action would surely occur were the grain in the least unfavorable and the cap-iron not used. Fig. 47.

The cap-iron should extend to within one-sixteenth of an inch of the cutting edge of the plane-iron in the

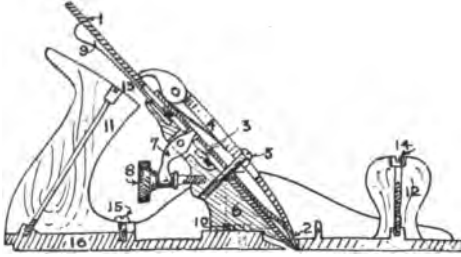

- | | |
|---------------------|-----------------------|
| 1 Plane-Iron. | 9 Lateral Adjustment. |
| 2 Cap-Iron | 10 Frog Screw. |
| 3 Plane-Iron Screw. | 11 Handle. |
| 4 Cap. | 12 Knob. |
| 5 Cap-Screw. | 13 Handle Bolt & Nut. |
| 6 Frog. | 14 Knob "Bolt & Nut." |
| 7 Y-Adjustment. | 15 Handle Screw. |
| 8 Adjusting Nut. | 16 Bottom. |

FIG. 46.

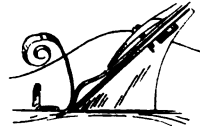

FIG. 47.

smooth-plane and three thirty-seconds in the jack-plane. Fig. 48. The screw which holds the plane-

iron and cap-iron together must be fastened with a screw-driver, tightly as possible. Many carpenters use the plane-cap for this purpose. Otherwise, a few strokes of the plane, and the plane-iron will have been forced up so that the cutting edge will not touch the wood. The reason for this action will be understood when it is seen that the lever of the brass adjusting nut does not act directly on the

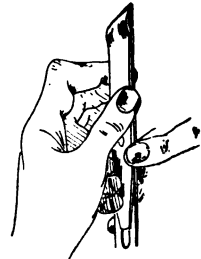

FIG. 48.

cap-iron but only on the plane-iron as it is carried along by being fastened with this screw to the cap-iron.

The cap-iron and plane-iron are fastened in the throat of the plane by a cap on one end of which is a little lever or cam.

Should this cam fail to hold the irons firmly, the screw which holds the cap to the frog should be turned with the screwdriver. It should be remembered, however, that this screw, once set, seldom needs adjusting.

Beginners frequently, in ignorance, place the plane-iron and cap-iron together so that the side of the plane-iron having the bevel is next to the cap-iron. This results in a loose acting cam. They should look to see that the irons are properly set before changing the screw.

Should it be impossible to force the cam into place without great pressure, first look to see whether the blade rests flat upon the frog before releasing the screw. Frequently the little lever which should enter the small opening in the cap-iron will be found to have entered the opening in the plane-iron only.

19. Adjustment of the Iron.—There are two adjustments for the blade of the modern plane. The first consists in turning the thumb-screw or adjusting nut, Fig. 46, that the plane-iron may cut a thicker or a thinner shaving. The direction in which it should be turned to give the desired result must be learned by experiment, for in some planes it is the reverse of what it is in others.

A little observation of the action of the screw upon the lever which connects it to the plane-iron will show that there is often quite a little lost motion so that it becomes necessary to turn the screw a little before the iron is raised

or lowered any. One soon learns by the sense of feeling when the lost motion has been taken up.

The second adjustment is by means of the lever, 9, Fig. 46. Moving this lever to the right or the left serves to straighten the plane-iron, so that the cutting edge shall extend evenly thru the mouth and not take a shaving thicker at one side of the iron than at the other.

In adjusting a plane-iron, turn the plane upside down with the toe towards you, hold it toward the light and sight along the bottom, Fig. 49.



FIG. 49.

If the plane-iron projects, observe whether it projects evenly or not. Usually one side will be found to project more than the other. Move the adjusting lever until it shall project uniformly. The cutting edge should project about the thickness of a piece of drawing paper for average work.

20. The Jack-plane.—The jack-plane is about thirteen inches long. Where a full equipment of planes is at hand, the plane-iron of the jack-plane is ground slightly rounding as is shown in Fig. 50A. The purpose of this plane is to remove rough or large quantities of wood and this shape of blade is best suited for that purpose. Of course the surface of the wood is left in hollows and ridges, and it is necessary to use another plane with a plane-iron ground

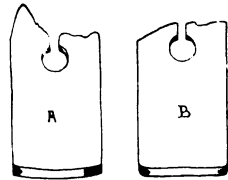

FIG. 50.

straight and set shallower in order to smooth the surface.

In manual-training schools where the jack-plane is made to serve the purpose of smooth-plane also, the plane-iron is sharpened straight across and the corners slightly rounded, B, Fig. 50.

21. The Smooth-plane.—The smooth-plane is shorter than the jack-plane. Fig. 51. It is used, as its name implies, for smoothing surfaces. As the straightening is supposed to have been previously done, the shorter length is no disadvantage. For fine work the cap-iron of this plane may be set as close as one thirty-second of an inch to the cutting edge of the plane-iron. The plane-iron should be set correspondingly shallow.

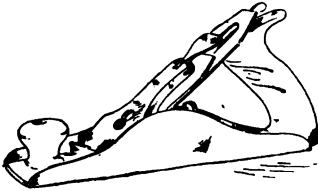

FIG. 51.

22. The Jointer.—This plane is used for straighten-

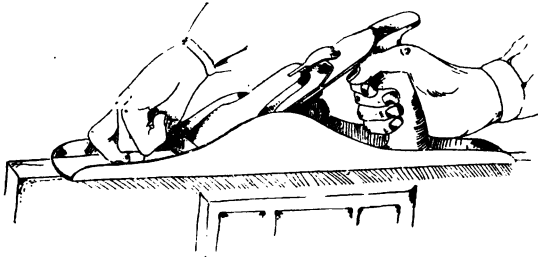

FIG. 52.

ing long and uneven stock. It is most commonly used for preparing the parts for glue joints. Fig. 52.

Its advantage lies in its length, often two feet or more, which prevents the blade from cutting in the hollow

places until all of the high places have been leveled. A short plane would simply follow the irregularities, smoothing but not straightening. The plane-iron of the jointer should be ground straight across.

Fore-planes are short jointers, next in size to the jack-planes, and are used for such work as straightening the edges of doors, windows, etc., when fitting them.

23. The Block-plane.—The block-plane is about six inches long. Fig. 53. It is made especially for cutting across the end of the wood. In addition to the adjusting nut, which is in a different position but serves the same purpose as in the jack-plane, and the lateral adjusting lever, there is a lever for ad-



FIG. 53.

justing the size of the opening at the mouth of this plane.

The block-plane differs from the planes just described in that it has no cap-iron, none being needed in end-planing. The plane-iron is put in place with the bevel side up instead of down as in the other planes.

The block-plane is not a necessity where a vise can be used for holding the piece to be planed. A smooth-plane or jack-plane may, if the plane-iron be set very shallow, do the work just as well. The block-plane is used mostly by carpenters in fitting together pieces which cannot be taken to the vise. Here the smallness of the plane and the fact that but one hand is needed to operate it are of very great advantage.

24. The Wooden Plane.—The old-fashioned wooden planes are still preferred by some woodworkers. The iron bodied planes have displaced them because of the

ease with which they can be adjusted rather than because they produce any better results. Wooden planes are subject to warp and as the bottoms become uneven thru wear, it is necessary to straighten and level them occasionally. The plane-iron and cap-iron of the wooden plane are fastened in the throat of the plane by means of a wooden wedge. This wedge is driven in place with the hammer. Fig. 54 shows the manner of holding the plane while setting the irons and wedge. If the plane-iron does not project enough, the iron is lightly



FIG. 54.

tapped as indicated. If too much projects, the stock is tapped as in Fig. 55. This figure also illustrates the manner of removing the wedge, two or three blows being sufficient to release it so that it can be withdrawn with the hand. In setting the plane-iron, should either corner project more

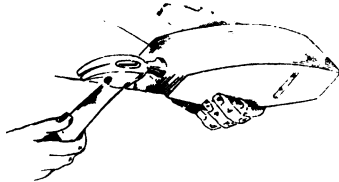

FIG. 56.



FIG. 55.

than the other, tap the side of the iron.

Fig. 56 shows the manner of holding the smooth plane in releasing the wedge, as well as when the cutting edge projects too much.

25. Woodworking Terms; Face Side, Face Edge.

—Fig. 57 locates the terms used in referring to the parts of a piece of lumber. "Grain" in wood is determined by the direction of its wood fibres. Length always refers to the direction parallel to the axis or center of the original log. A board may be wider than it is long. Wood splits easiest along the grain. When the fibres approach the surface obliquely, the surface will be roughened unless one and only one direction of planing is used. When the surface is thus roughened the planing is said to be "against the grain."

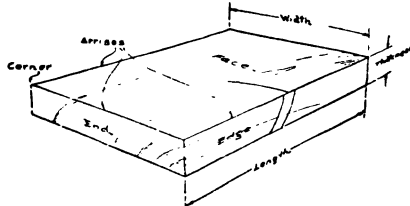

FIG. 57.

The first surface and the first edge selected serve a special purpose and are given special names. The first surface is called the face side, and the first edge, the face edge; both may be referred to as the faces. These faces are sometimes known by other names such as working face and joint edge, marked face and marked edge, etc., but their meaning is the same.

That these faces may be known, they are marked with pencil with what are called face marks. There are various ways of making face marks. Unless otherwise instructed, the marks may be made as in Fig. 57; for the face side, a light slanting line about one inch long extending to the edge which is to become the face edge; for the face edge, two lines across the edge. The marks

on both face side and face edge should be placed about the middle of the piece and close together.

These two surfaces are the only ones marked. From one or the other of these, measurements and tests are made. In squaring up stock, for illustration (which means to reduce a piece of rough lumber to definite length, width and thickness so that it shall have smooth, flat sides at right angles to each other) the gage block is held against one or the other of these faces only, and the beam of the try-square when testing for squareness is placed against one or the other of these faces only.

26. General Discussion of Planing.—Select for the first surface, which we shall call the face side, the better of the two broad surfaces. Knots, sap, wind, shakes, etc., should there be any, must be taken into account when passing judgment. Often the two sides are so nearly alike that there is little reason for choice.

Where several parts are to be fitted together, the faces are turned in; in this case, the best surfaces should not be selected for faces. Chapter VII, section 75.

Notice the direction of the grain and place the piece so as not to plane against it. In Fig. 58 plane from A toward B or the surface will be roughened instead of smoothed. When the stock is rough, the direction of the grain



cannot be told readily. A few strokes of the plane will give the desired information. As most stock is to be planed to size, it is well to test with the rule before beginning to plane, so as to know just how much margin has been allowed. If you find you cannot true this first surface without getting the piece within one-sixteenth of an inch of the

thickness required, ask your instructor to show you where the trouble lies.

As few shavings as possible, and those thin ones, with the proper result attained, show forethought and care. Nowhere can good, common sense be used to better advantage than in learning to plane.

When planes are not in use they should be laid on their sides, or otherwise placed so that the cutting edge shall not touch anything:



FIG. 59.

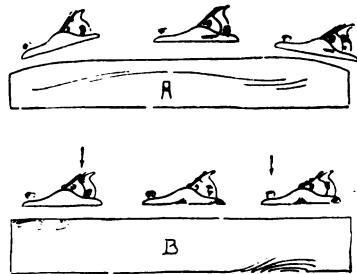

FIG. 60.

For roughing off and straightening broad surfaces, the jack-plane should be used, and this followed by the smooth-plane.

When using the plane, stand with the right side to the bench; avoid a stooping position. Fig. 59. The plane should rest flat upon the wood from start to finish. Press heavily upon the knob in starting and upon the handle in finishing the stroke. Unless care is taken to hold the plane level in starting and stopping, the result will be as indicated in Fig. 60A.

Take as long a shaving as the nature of the work will permit. In planing long boards or where it is desired to lower one particular place only, it becomes necessary to stop the stroke before the end of the board is reached. That no mark shall show at the place where the plane-iron is lifted, it is necessary to feather the shaving. This is done by holding the toe of the plane upon the board and raising the heel as the stroke proceeds, beginning just before the stopping point is reached. If the cut is to commence other than at the end of the piece, lower the heel after having started the forward stroke with the toe upon the board.

It is customary to raise the heel of the plane lightly on the backward stroke that the edge may not be dulled.

27. Planing First Surface True.—A true surface is one which is straight as to its length and width, and which has its surface at the four corners in the same plane.

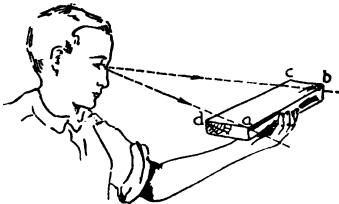

FIG. 61.

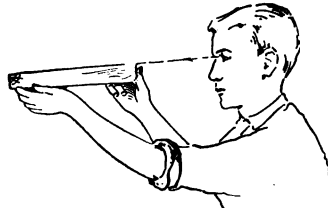

FIG. 62.

Before beginning to plane hold the piece toward the light, close one eye and sight as in Fig. 61. If the surface is not warped or in wind, the back arris *ab* will appear directly behind the front arris *cd*. Also sight the arrises for straightness, Fig. 62, being careful to hold so as to get the full benefit of the light. Again, test from arris to arris, Fig. 63. The try-square may be used either side up, but

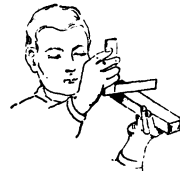

FIG. 63.

the beam must not be held against either edge. It is not for squareness but for straightness that this test is made.

When the surface has been planed so that it fulfills the tests by sighting described above, an additional test may be given it. Should the board be of any considerable width—three or more inches—the following test will prove sufficient: Place a straight-edge along each of its two diagonals, then lengthwise, then crosswise the surface

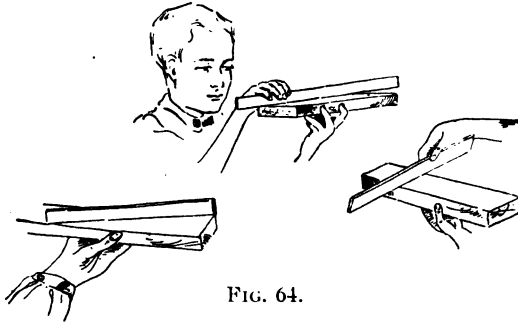

FIG. 64.

planed. If no light can be seen between the piece and the straight-edge in any of these four tests, the surface may be considered level or true. Fig. 64.

A second test, one which will answer for narrow as well as broad surfaces, differs from the above only in the manner of determining whether the surface is in wind or not. Two sticks, called winding sticks are prepared by planing

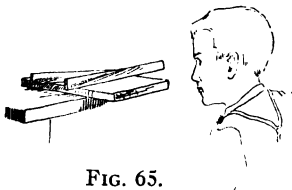

FIG. 65.

ing their two opposite edges straight and parallel to each other. These sticks are placed across the surface to be tested, close to the ends,

and a sight taken over their top edges. If the surface is in

wind the edges cannot be made to sight so that one edge will appear directly back of the other, Fig. 65; one end of the back stick will appear high, at the same time the other one will appear low with reference to the edge of the fore stick. The back corner is high only as compared with the fore corner. The wind may be taken out of the surface just as well by planing the fore corner which is diagonally opposite. Usually, equal amounts should be planed from the surface at each of these corners. If, however, the board is thicker at one corner than the other, it is best to take the whole amount at the thicker corner.

28. Planing First Edge Square with Face Side.—

Make a preliminary test with the eye before beginning to plane. Sight the arrises of the edge to see where it needs straightening. Examine the end to see which arris is high. Also look to see which way the grain runs. Avoid imperfections in the wood as far as possible in choosing this edge.

It is the part of wisdom to examine the plane-iron to see that the surface planing has not caused the cutting edge to project unevenly. A plane, set out of true, is likely to cause hours of extra work; it defeats every effort that may be made to hold the plane properly.

Strive to get shavings the full length of the piece, especially on the last few strokes.

The smooth-plane is little if ever used for edge planing on account of its short length. In using the jack-plane in which the edge is slightly rounded, thus making a shaving thicker in the middle than at the edges, avoid tilting the plane to make it cut on one side rather than the other. Move the whole plane over to the high side so that the

middle of the cutting edge shall be directly over the high place. Keep the sides of the plane parallel with the edge so as to get the full benefit of the length of the plane.

The two tests which this first edge must fulfill are: First, that it shall be straight; second, that it shall be square with the face side. Fig. 6, Chapter I, shows the method of testing for squareness. As in planing the face side, try to accomplish the desired result with as few shavings as possible.

The caution about planing the first surface, where a definite size is to be attained, applies equally to planing the first edge.

When the edge has been properly trued, put on the face marks suitable for the face edge.

29. Finishing the Second Edge.—A line gaged from the face edge indicates the proper stopping place in planing the second edge. This line, if lightly made, should be half planed off.

As the line is parallel with the face edge, no straight edge test is necessary. The try-square test for squareness, the beam being held against the face side, must be frequently applied when approaching the gage line.

Where the amount of waste stock to be planed is about an eighth of an inch, the plane-iron may be set a little deeper than average. When near the line, however, it must be set quite shallow. If the waste stock measures more than three-sixteenths of an inch, the rip-saw should be used, sawing parallel to the gage line and about one-eighth of an inch away from it.

30. Finishing the Second Side.—Lines gaged from the face side on the two edges show the amount to be planed.

The test for this side is made by placing the straight-edge across the piece from arris to arris as the planing proceeds, to see that the middle shall be neither high nor low when the gage lines have been reached. No other test is necessary; a little thought will show the reason.

Never attempt to work without lines. If by mistake you plane out your line, take the piece to your instructor at once, unless you have been otherwise directed, that he may tell you what to do.

31. Planing the First End Square.—See that the cutting edge is very sharp and that the plane-iron is set perfectly true and very shallow. Examine one of the ends of the piece by placing the beam of the try-square against the face side, then against face edge, to locate the high places. Fig. 6.

In free end planing, the cutting edge must not be allowed to reach the farther corner or the corner will be broken



FIG. 66.

off. Plane only part way across the end, stopping the cutting half an inch or more from the far edge. Fig. 66. After a few strokes in this direction, reverse the position and plane in the opposite direction, stopping the cutting edge half an inch or more from the first edge.

Keep testing the end as the planing proceeds, that you may know what you are doing. Remove no more material than is necessary to square the end, and lay on the rule

occasionally that you may not endanger the correct length in your efforts to square this end.

32. Finishing the Second End.—Knife lines squared entirely around the piece, at a given distance from the end first squared, limit the amount of the planing that can be done on this end. If the waste stock is over one-eighth of an inch the saw should be used to remove all but a thirty-second of an inch before beginning to plane. Watch the lines. If you are uncertain as to their accuracy, test this end as you did the first one.

33. End Planing with the Shooting Board.—Fig. 67 illustrates a way in which the ends of narrow pieces may be easily squared. The plane is pressed to the shooting board with the right hand. The left hand holds the piece against the stop and to the plane.

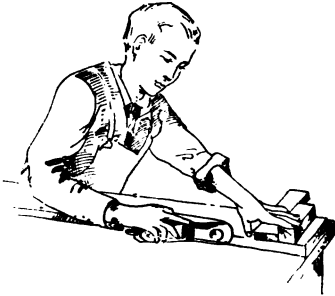

FIG. 67.

The face edge of the piece should be held against the stop; the wood must not be

allowed to project beyond the stop. If it does, the corners, being unsupported, will be broken away as in free planing when the cutting edge is accidentally shoved entirely across the piece.

The bench hook makes an admirable shooting board.

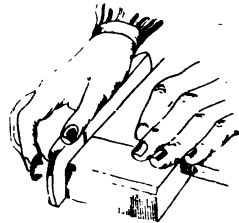

FIG. 68.

34. Rules for Planing to Dimensions.—

1. True and smooth a broad surface; put on a face mark. This becomes the face side.

2. Joint (straighten and square) one edge from the face side; put on a face mark.

3. Gage to required width from the face edge, and joint to the gage line.

4. Gage to required thickness on both edges from the face side; plane to the gage lines.

5. Square one end from the face side and face edge.

6. Lay off with knife and square the required length from the squared end; work to the knife line.

The rules just given are the ones used when stock is entirely in the rough or where it is desired to have the surfaces as nearly perfect as possible. While every student should know how, and be able to square up rough stock quickly and accurately, he should understand that modern mill practice makes it unnecessary to use stock entirely in the rough. Most of the lumber used by cabinet makers and carpenters is machine planed, Fig. 119, on two surfaces to stock thicknesses.

The nature of the piece of woodwork that is to be done determines the method to be used in squaring up mill-planed stock. Your instructor will provide specific directions for the order of procedure until you have acquired the ability to see for yourself the correct method to be used.

35. Planing a Chamfer.—

Fig. 69 illustrates a good way to lay out a chamfer. A notch in the back end of the gage-stick holds the pencil in position. Holding pencil in this way, draw lines on face and edge indicating width of the

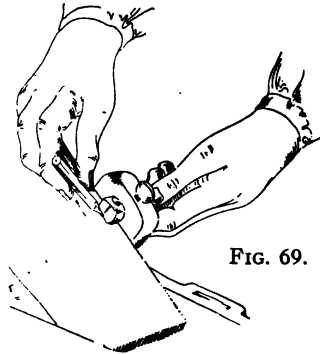

chamfer. Fig. 70 illustrates the manner of block-planing a chamfer, the piece being held on the bench-hook.

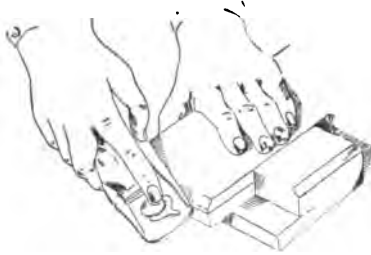

FIG. 70.

Where the piece can be placed in the vise, Fig. 71 illustrates the method of planing a chamfer with one of the larger planes. First, plane the chamfers which are parallel to the grain; then the ends. If the plane-iron is sharp and set shallow, it can be run

entirely across without danger of splitting the corners.

Hold the plane parallel to the edge in planing with the grain. Swing it to an angle of about forty-five degrees

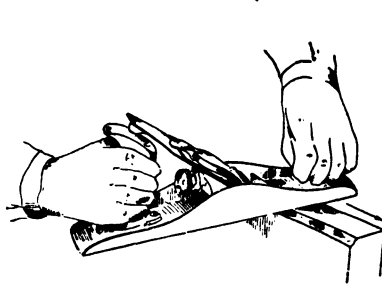

FIG. 71.

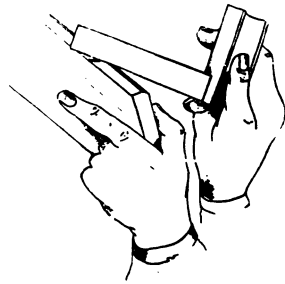

FIG. 72.

in end chamfering, but move it parallel with the edge, and not with the length of the plane.

The eye will detect inaccuracies in planing. If further test is desired, Fig. 72 illustrates one.

CHAPTER IV.

BORING TOOLS—BORING.

36. Brace or Bitstock.—Fig. 73 illustrates a common form of brace. This tool is used for holding the various kinds of bits which are used in boring, reaming, etc.

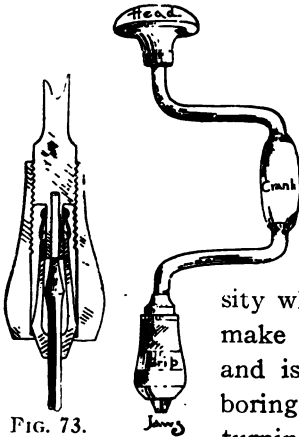

FIG. 73.

The ratchet brace consists of essentially the same parts but in addition has an attachment which permits of the crank's acting in one direction or the other only. It is a neces-

sity where the crank cannot make an entire revolution, and is very convenient for boring in hard wood or for turning large screws.

To insert a bit, hold the brace firmly with the left hand, revolve the crank until the jaws are opened far enough to allow the bit tang to pass entirely within so that the ends of the jaws shall grip the round part—the shank of the bit. Still firmly holding the brace, revolve the crank in the opposite direction until the bit is firmly held. Fig. 74.

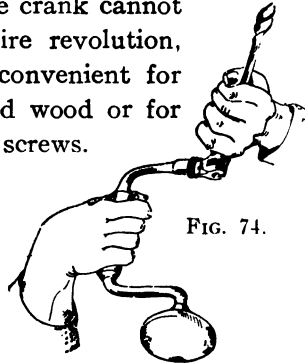

FIG. 74.

37. Center Bit.—The old-fashioned center bit, Fig. 75, is still used by carpenters for certain kinds of work. It

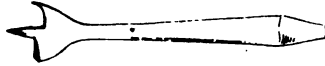

FIG. 75.

has, for the most part, given way to the more modern auger bit.

38. The Auger Bit.—The auger bit, Fig. 76, is used for all ordinary boring in wood. The action of an auger bit is readily understood by referring to Fig. 76. The spur



FIG. 76.

draws the bit into the wood. The two nibs cut the fibers, after which the lips remove the waste, later to be passed along the twist to the surface.

Auger bits are usually supplied in sets of thirteen, in sizes varying from one-fourth of an inch to one inch, by sixteenths. Drill bits vary by thirty-seconds.

The size of hole that an auger bit will bore can be told by looking at the number on the tang or shank. If a single number, it is the numerator of a fraction whose denominator is sixteen, the fraction referring to the diameter of the hole which the bit will bore.

Exercise care in laying down a bit; it is easily dulled. Do not use a good auger bit where there is any danger of striking nails or other metal.

Auger bits are easily sharpened, a small file being used, but they are more easily spoiled by improper filing, and

no student should attempt to sharpen one without having personal direction from his instructor.

39. The Drill Bit; The Gimlet Bit.—The drill bit, Fig. 77, is quite hard and may be used for boring in metal as well as wood. It is easily broken and especial



FIG. 77.



FIG. 78.

care must be taken to hold the brace firmly. Do not try to change the direction of the boring by inclining the brace after the bit has started into the wood.

In boring hard wood or metal, make a "seat" for the point with an awl, or in metal with a center punch. Otherwise it is difficult to start the bit in the exact place.

The gimlet bit, Fig. 78, is used mainly for boring holes for screws. Diameters vary by thirty-seconds of an inch.

40. Countersink Bit.—Fig. 79 is an illustration of a rosehead countersink. This tool is used for enlarging

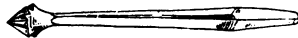

FIG. 79.

screw holes made with the gimlet so that the heads of the screws may sink into the wood even with or below the surface.

41. The Screwdriver Bit.—The screwdriver bit, Fig. 80, is not a boring tool, but as it is used in connection



FIG. 80.

with the brace it is inserted here. It will be found convenient where large screws are to be inserted. Where a

large number of screws are to be inserted it will permit very rapid work.

In using the screwdriver bit, especially in driving screws into hard wood, the bit will tend to jump out of the groove in the head of the screw. To avoid its jumping entirely out and marring the wood, take but half a revolution at a time, then move the brace backward slightly before proceeding again. This allows the bit which has partly worked its way out of the groove to drop back again.

The manner in which a screwdriver bit is sharpened has much to do with its working properly.

42. The Brad-awl.—The brad-awl is used for boring very small holes. Unlike most boring tools it does not remove the material from the opening it makes.

The cutting edge of the brad-awl should be placed across the grain in starting, and the tool turned half way around and back again, repeating until the proper depth has been bored. It is withdrawn with similar turnings. Fig. 81.

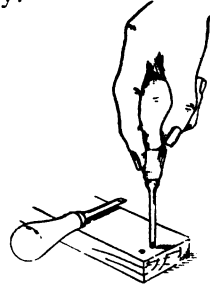

FIG. 81.

Patent spiral screwdrivers and automatic drills have come into quite common use in recent years. They are used mainly upon light work, their advantage being the rapidity with which they do their work.

43. Positions while Boring.—Fig. 82 illustrates the position to be taken in horizontal boring. The head of the brace is held steady by bracing the body against the hand which holds it.

To tell whether a bit is boring a hole in the direction which is wanted, it is necessary to sight the bit and brace from two directions at right angles to each other. In horizontal boring, the first sight should be made while in

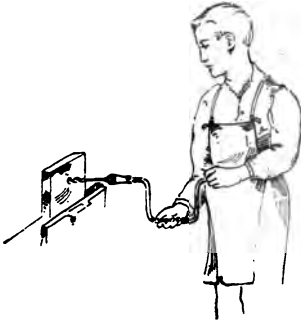

FIG. 82.



FIG. 83.

the position shown in the illustration. The second position for sighting would be obtained by inclining the upper part of the body until the eye is on a level with the bit. In vertical boring, Fig. 83, the sighting of the bit would be done across the piece, then along it.

Changing from one position to the other can be done easily and without interfering with the boring and should be done quite often, until the bit has entered well within the wood.

Fig. 84 illustrates a position which is frequently taken when boring in hard wood, or when using the screwdriver bit on large screws. The chin, resting upon the left hand, steadies the tool in the first case, and can be made to give additional pressure in the second.



FIG. 84.

44. Thru Boring.—To avoid splitting the wood around the edge of the hole when it is desired to make a hole entirely thru a piece, bore from the face side until the point of the spur can be felt on the back. Then reverse the position of the board and, inserting the point of the spur in the hole just made, finish the boring from the back side. The bit must be held perpendicular to the surface while boring from the second side, as well as the first, or some of the edge of the hole will be broken from the first side as the bit is forced thru.

45. Boring to Depth.—When it is desired to bore to

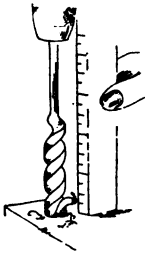

FIG. 85.

a given depth, turn the crank of the brace until the lips of the auger are just ready to cut the surface. With the rule, measure the distance from the surface of the piece to the grip of the brace. Fig. 85.

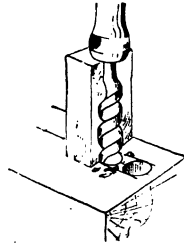

FIG. 86.

The brace may then be turned until this distance is diminished by the amount which represents the desired depth of the hole.

Where many holes of the same depth are to be bored much time will be saved by cutting a block the length of the exposed part of the bit when the hole is to the required depth. This can be placed beside the bit so that the grip will strike it, Fig. 86; or a hole may be bored thru the block, the block being allowed to remain on the bit.

CHAPTER V.

CHISELS AND CHISELING.

46. **Chisels.**—Chisels are usually divided into two classes, the framing chisel, which is heavy and strong,



FIG. 87A.



FIG. 87B.

and the firmer chisel, which is lighter. The framing chisel, Fig. 87 A, is used on heavy work such as the frames of buildings. Its handle is usually fitted into a socket and the top is tipped with leather or banded with iron to prevent its splitting when pounded with the mallet. The firmer chisel, Fig. 87B, is used for lighter work without the mallet, such as paring, and its handle is usually fitted upon a tang.

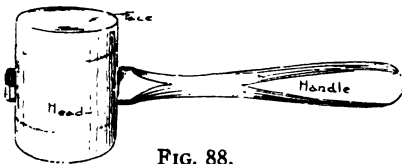

FIG. 88.

The mallet, Fig. 88, should always be used for driving chisels, gouges, pins, etc. Its blow is not so concentrated as that of the

hammer and therefore not so likely to injure the chisel handle. It should never be used for driving nails—wood

for pounding wood, metal for pounding metal, is a good rule to follow.

The size of a chisel is indicated by the width of the cutting edge and varies from one-eighth of an inch to two inches.

To do good work a chisel must be kept very sharp, and special care must be taken in handling it. Both hands should, at all times, be kept back of the cutting edge.

The action of a chisel driven into the wood with a mallet is somewhat similar to that of a wedge. This must be taken into account when cutting dados, mortises, etc.,

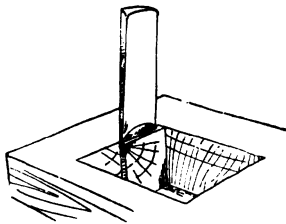

FIG. 89.

where it is desired to cut away the waste exactly to a given line.

If the chisel were beveled on two sides the action would be the same as that of a wedge; that is, the wood would be pushed to either side equally. Since the bevel is on one side only, beginners

are prone to think that the wedging takes place on one side only, the bevel side. Most of the wedging does take place on the wood at the bevel side, but there is enough pressure against the bevel to force the flat side of the chisel over the line slightly onto the part which it is not desired to cut. To overcome this action, chisel a line parallel to the given line, about one-sixteenth of an inch away from it, on the waste. When the opening has been cut to depth, the chisel may be set exactly in the given line and driven to depth. The narrow margin of waste wood breaks off; the pressure against the bevel is therefore almost nothing. Fig. 89.

47. Horizontal Paring Across the Grain.—In horizontal chiseling the work should be fastened so as to leave both hands free to guide the chisel.

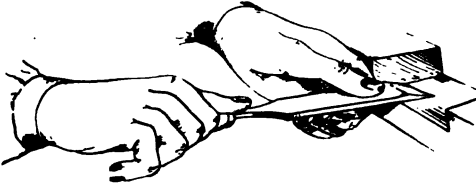

FIG. 90.

Fig. 90 shows the manner of holding the chisel. The left hand rests against the piece of wood and the chisel is kept from cutting too far by the pressure of the thumb and fingers of this hand. With the bevel side of the blade up, move the handle from right to left carefully while pushing it forward; pare off pieces about one-sixteenth of an inch thick half way



FIG. 91.

across from edge to edge. Fig. 91. When within a thirty-second of an inch from the gage line hold the chisel so that its cutting edge shall move obliquely across the grain and pare just to the gage line. The direction of the grain will determine which corner of the chisel is to cut ahead. In starting the last cut place the chisel squarely in the gage line. The piece should be reversed and the cut finished by cutting in a similar manner from the second side.

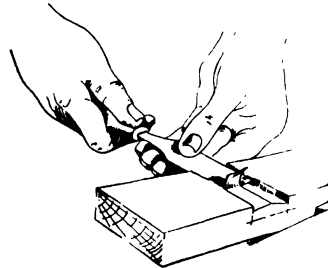

FIG. 92.

Fig. 92 illustrates a second method of horizontal paring. It differs from the first in that the chisel is turned while in the horizontal position so that one of the edges is free of the wood. By cutting first

with one edge free, then the other, the surface may be lowered until only a low ridge extends across the piece from edge to edge. This ridge may then be removed by cutting to the gage line in the usual manner.

If the chisel is properly sharpened the surface may be left as smooth and as level as if planed.

48. Vertical Paring.—In vertical paring hold the chisel as shown in Fig. 93. The left hand resting upon the wood holds the wood in place, while the index finger and thumb of the left hand assist in placing and guiding the chisel. Only a small portion of the cutting edge can be used in vertical paring; the amount will depend upon the hardness of the wood and the strength of the student. Ordinarily, not more than one-quarter of an inch of the chisel width can be used for very soft woods and not more

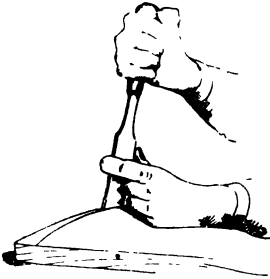

FIG. 93.

than one-eighth for hard woods. That part of the blade which is not used for cutting purposes is used as a guide to insure each cut being in the same plane as the last. The chisel should be inclined toward the worker, the unused part of the blade pressed firmly against the part of the surface already cut. To make the cut, apply the needed pressure, at the same time moving the handle forward until the chisel shall have a vertical position as shown by the dotted lines in Fig. 94. Care must be taken to keep the broad surface of the chisel at right angles to the sur-

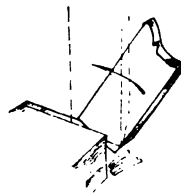

FIG. 94.

face of the work at all times. The worker should so stand that he may look along the line as he cuts it. Otherwise he is in no position for sighting the chisel plumb.

49. Oblique and Curved Line Paring.—Whether cutting with the grain or across the grain, care must be taken in oblique and curved line paring to cut from the straight grain toward the end grain. Fig 95.

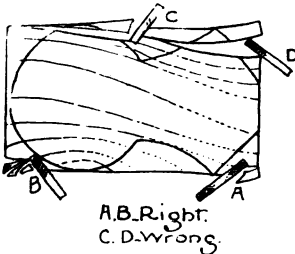

FIG. 95.

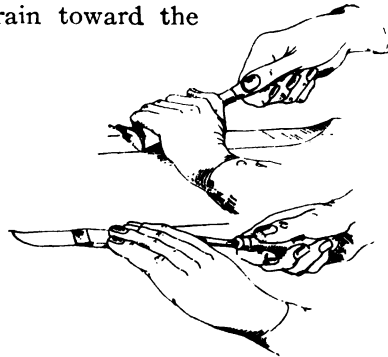

FIG. 96.

50. Paring Chamfers.—Fig. 96 illustrates two ways of holding the chisel in cutting chamfers. In one, the bevel side of the chisel is down and the cutting edge held at right angles to the grain. In the other, the flat side of the chisel is down and the cutting edge is worked obliquely to the grain.

Frequently it is desired to chamfer or bevel the end of a piece of wood with the chisel. To do this hold the cutting edge obliquely to the grain, the flat side of the chisel down. Fig. 97. The use of the framing chisel is described in connection with the making of the mortise. Part II.

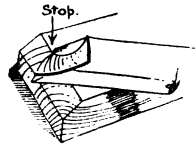

FIG. 97.

51. The Firmer Gouge.—Fig. 98. The gouge is curved in section and may have its bevel on either side. It is used for cutting grooves and hollowing out surfaces. The size of the gouge is determined by measuring the straight



FIG. 98.

distance between the corners of the cutting edge.

When roughing out where rather thick shavings may

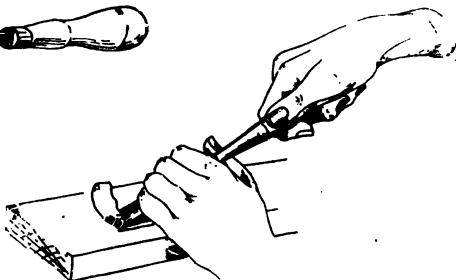

FIG. 99.

be taken, the gouge should be held as in Fig. 99, the blade being held firmly in the left hand. When taking off thin shavings and in finishing, the tool should be held as shown in Fig. 100. In using the gouge avoid short strokes. Try to take as long and as even shavings as the nature of the work and the wood will allow. The thinner the shaving, the easier it will be to cut smoothly. A circular movement imparted to the cutting edge will enable the tool to cut more easily the end grain of wood, as is necessary in cutting the ends of grooves in pen-trays, etc.

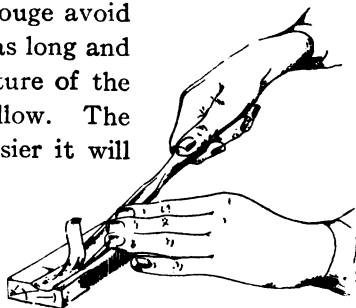

FIG. 100.

52. Grinding Beveled Edge Tools.—When edged tools become rounded over by repeated whettings or when they are nicked too deeply for the oilstone to remove the

nicks, the grindstone is needed to cut the metal to the proper angle. Fig. 101 shows the manner of holding the chisel upon the stone. The tool must be held firmly and at the same angle. This angle will depend upon the temper of the tool and the kind of wood to be cut, whether

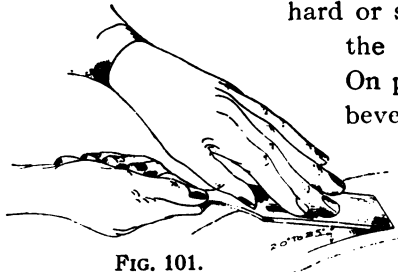

FIG. 101.

hard or soft, soft wood allowing the use of a sharper angle. On plane-irons the length of bevel, or grind should be three-sixteenths or one-fourth of an inch; on the chisels, three-

eighths or one-half an inch. The tool should not be kept in the middle of the stone but should be moved from right to left and vice versa across it as the grinding proceeds, that the surface of the stone may be worn as evenly as possible.

The pressure of the left hand should be so applied that the stone shall cut straight across the blade. Examine the tool often, being careful to replace it each time as nearly as possible at the same angle.

Fig. 102 shows the flat bevel which is to be obtained, also the rounded effect caused by frequent changing of the angle at which the tool is held.

Grindstones are usually turned towards the tool because in doing so they will cut faster.

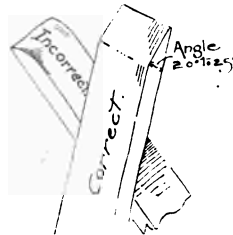

FIG. 102.

Water is caused to flow on the stone for two reasons: To keep the edge of the tool from being burned or softened by the heat which friction would generate, and to wash

off the particles of steel and stone, thus keeping the cutting surface clean that it may cut the more freely.

53. Whetting Beveled Edge Tools.—The grindstone does not sharpen tools; that is the work of the oilstone. No tool, after it has been ground, is ready for use until it has been whetted.

54. Oilstones.—Oilstones in common use are of two kinds; those which are of very fine-grained natural stone and those which are manufactured by pressing a powdered, metal cutting substance into rectangular forms. In selecting an oilstone it should be remembered that the finer the grain the keener the edge it will produce but the longer time it takes to produce it.

Manufactured stones are frequently made "two in one," that is, coarse and medium or medium and fine are put together in such a way that one side gives a rapid cutting and the other a slower but smoother cutting surface. The advantage of such a stone is easily understood.

Oil is used on stones to cleanse the pores of the stone of the little particles of steel cut from the tool. Were it not for the oil mixing with and removing these particles the surface of the stone would soon become smooth and friction so reduced that the cutting power would be greatly interfered with.

While but a part of the stone need be used at one placing of the tool, effort should be made to utilize as much of the surface as possible that the surface may be kept level as long as possible. Stones that have worn uneven may have their surfaces leveled by rubbing them on a piece of sandpaper or emery paper placed on a flat surface.

55. Sharpening the Chisel.—Hold the tool as shown in Fig. 103. Suppose the grinding produced a bevel of about twenty-five degrees, in whetting effort should be made to hold the blade so as to produce an angle slightly

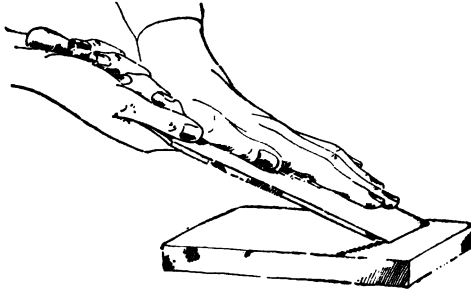

FIG. 103.

greater than this. The amount shown in Fig. 107 a and b is exaggerated. The aim at all times should be to keep this second angle as near like the first as is possible and still get a straight bevel to the cutting edge.

To get the tool into proper position, lay it flat on the stone with the beveled edge resting in the oil which has previously been placed on the stone. The oil should be drawn to the place where the whetting is to be done, the back edge of the bevel being used to push and draw it to place. Gradually raise the handle of the tool until the oil is expelled from under the cutting edge; it is then in position. Use just enough oil to keep the surface well moistened where the whetting is being done.

Rub the chisel back and forth, keeping it at the same angle all the time. A rocking motion and frequent change of angle will result in a rounded end instead of a straight bevel. Some workmen prefer to give the blade a circular instead of the forward and backward movement.

To remove the feather or wire edge which frequently results from over-whetting or from grinding, proceed as follows: Hold the tool with the flat side down, just a little above the stone, with the handle just a very little higher than the cutting edge. In one stroke push the cutting edge forward and down on the stone, at the same time lowering the rear end to a level with the cutting edge. The effect of this movement is to turn the wire edge under and cut it off. If the first attempt does not remove it, whet the bevel just enough to turn the edge back on the flat side and try again. The presence of a feather edge is detected by rubbing the fingers along the

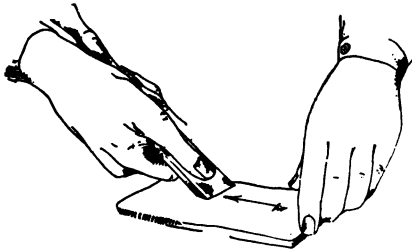

FIG. 104.

flat side over the cutting edge.

If a still keener edge is desired it may be obtained by the use of a strop, a piece of leather fastened to a flat surface. Hold the

tool as shown in Fig. 104 and draw it toward you several times. Then hold it with the flat side down and draw it back once or twice.

The angles of the bevels of a gouge are similar to those of a chisel. In sharpening, hold the tool at right angles to the edge of the stone, instead of parallel as with the chisel. Move it lengthwise of the stone, at the same time rotating the handle so as to give the blade a circular motion as from A to B, Fig. 105.

The feather edge which is formed on the inside is removed by a few strokes of a stone called a slip. Hold

the slip firmly against the face so as not to form a bevel. Fig. 106. Slips are of various sizes; one that fits the curvature of the gouge should be selected.

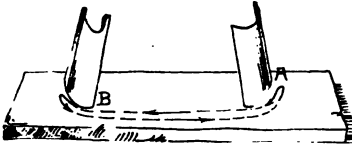

FIG. 105.

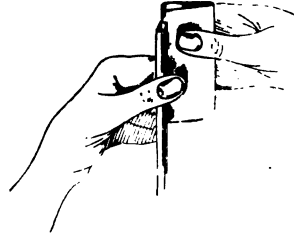

FIG. 106.

56. Sharpening Plane-irons.—Plane-irons are sharpened straight across like the chisel, with the exception of the jack-plane, as previously noted. Their corners, however, are very slightly rounded off to prevent their leaving marks on the wood. Where one plane is made to serve the purpose of smooth, jack and fore-plane, it should be ground straight across. In whetting, increase the pressure on the edges alternately so as to turn up a heavier feather edge there than in the middle, thus rounding the whole end very slightly. This feather edge may be removed in the usual manner.

57. To Tell Whether a Tool is Sharp or Not.—Examine the cutting edge, holding the tool toward the light. If the tool is dull, the cutting edge will appear as a white line, the broader the line the blunter the edge. Fig. 107A. If the tool is sharp, no white line can be seen. Fig. 107B. (See page 64.)

A better way—the method a mechanic would use—is to test the edge by drawing the thumb along it lightly.

Fig. 108. If the tool is sharp one can feel the edge "taking hold." If dull, the thumb will slide along the edge as it would along the back of a knife blade.

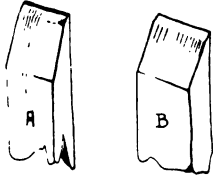

FIG. 107.



FIG. 108.

Good judgment is necessary in this test or a cut on the thumb may be the result. No pressure is required, just a touch along the edge at various points

What actually takes place is this: The cutting edge, if sharp, cuts the outer layer, the callous part of the ball of the thumb, just a little. The sense of feeling is so keen that the resulting friction, slight as it is, is transferred to the brain of the worker long before any injury need be done the thumb. If the tool is dull, no cut, hence no friction can result. Do not use the finger, as it is not calloused as is the thumb.

CHAPTER VI.

FORM WORK; MODELING.

58. Making a Cylinder.—The cylinder is evolved from the square prism by increasing the number of sides until a prism is formed with so many sides that its surface can be easily transformed into a cylinder by means of sand-paper.

(1) Begin by making a square prism which shall have the same dimensions for its width and thickness as is desired for the diameter of the cylinder. (2) Change this square prism to a regular octagonal or eight-sided prism by planing off the four arrises.

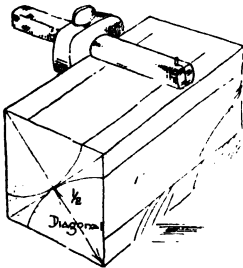

FIG. 109.

which indicate the amount to be taken off of each arris are made by holding the gage block against each of the surfaces and gaging from each arris each way, two lines on each surface. These lines must be made lightly. The distance at which to set the spur of the gage from the head is equal to one-half the diagonal of the square end of the prism. Fig. 109. Since the ends are less likely to be accurate than any other part, it is advisable to get this distance as follows: Lay off two lines on the working face a distance apart equal to the width of the prism. These lines with the two arrises form a

square the diagonal of which can be measured and one-half of it computed.

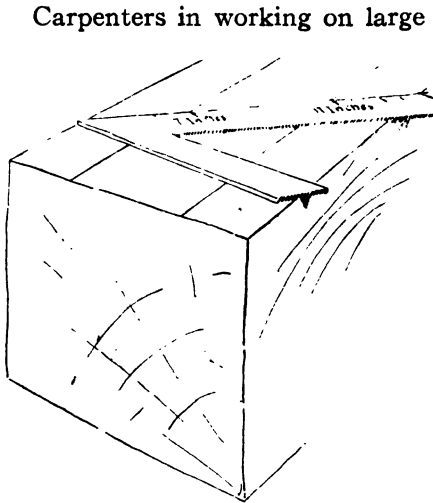

FIG. 110.

Carpenters in working on large timbers lay the steel-square diagonally across so that there are twenty-four divisions from arris to arris. They then mark off the timber at seven and seventeen inches. Fig. 110. These numbers, while not mathematically correct, are near enough for practical purposes. In planing the arrises off, the piece may be held in

the vise or placed against the bench-stop. Fig. 111. Care must be taken not to plane over the lines, for not only is the one side enlarged, but the adjacent side is lessened, thus exaggerating the error.

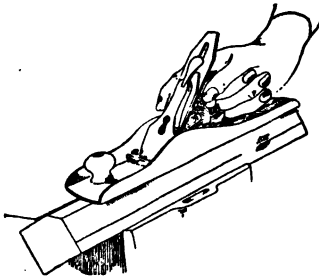

FIG. 111.

(3) Judging with the eye the amount to take off, plane the eight arrises until there are sixteen equal sides.

Again plane the arrises, making the piece thirty-two sided. On a small piece this will be sufficient; if the piece

is large, the process may be continued until the piece is

practically a cylinder. (4) To finish a small cylinder wrap a piece of sandpaper around it, rub lengthwise until the surface of the wood is smooth and the piece feels like a cylinder when revolved in the hand.

59. The Spokeshave.—Fig. 112. The spokeshave is used principally to smooth curved surfaces. It may be



FIG. 112.

drawn toward or pushed away from the worker, whichever is more convenient. By means of screws the blade may be adjusted to take light or heavy shavings. The spokeshave is practically a short plane with handles at the sides, and in using it the aim should be, as with the plane, to secure silky shavings of as great length as the nature of the work will allow.

60. Making Curved Edges.—To make curved edges on a board, finger-gage on each side, lines which shall indicate the amount of curvature. Fig 113.

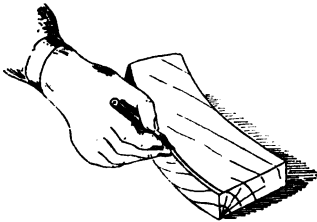

FIG. 113.

If the curve is to be a gradual one reaching from one of these lines over the middle of the edge to the other, two lines should also be finger-gaged on the edge. Finger-gage from each side using a distance equal to one-fourth the whole thickness of the piece.

With the spokeshave, Fig. 114, carefully cut off the two arrises to the pencil lines so as to form two bevels. This gives three surfaces to the edge of the board. Estimating the amount with the eye, cut off the two arrises formed by these three surfaces until five equal surfaces are formed in their place.

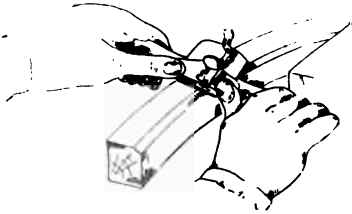

FIG. 114.

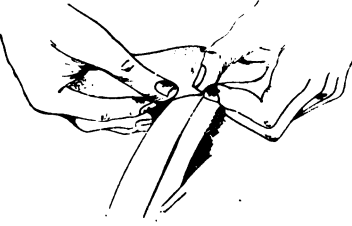

FIG. 115.

are formed in their place. This process may be repeated until the surface of the edge is practically a curved surface. With a piece of sandpaper held as shown in Fig. 115, rub until the surface is smooth and evenly curved.

61. Modeling.—This term is used to apply to the method of making objects of such irregular form that the judgment of the worker must be depended upon to give the correct result without the aid of gage and knife marks. The forming of a canoe paddle or a hammer handle is a good illustration.

Generally a little forethought will show a way in which the piece of work may be partly laid out with knife, square and rule. To illustrate, take the hammer handle, Fig. 116. The steps would be as follows: First, plane a face side and a face edge, and square the two ends so that the piece shall have the length desired for the finished handle. Second, draw a center line on the face side, parallel to the face edge and lay off on either side of this the

two straight lines which shall indicate the amount of taper; also sketch in the lines of curvature. Plane the two edges to the tapering lines and square with the face side. Then cut to the curved

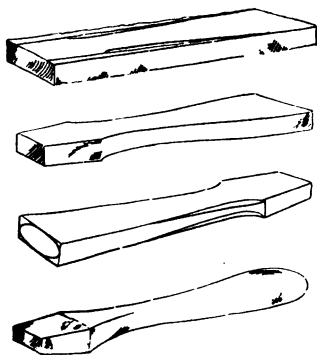

FIG. 116.

lines, keeping this surface also square with the face side. In a similar manner, lay off on the face edge a center line parallel to the face side, mark the taper and lines of curvature, and work these surfaces as in the second step. Third, the piece may be laid off still further by drawing on the larger end the form of the ellipse

which that end is to assume. With spokeshave, judging the curves of the middle with the eye, work out the desired form. The steel scraper is to be used for finishing after the piece has been made as smooth as is possible with the spokeshave.

CHAPTER VII.

1. LAYING OUT DUPLICATE PARTS.
2. SCRAPING AND SANDPAPERING.
3. FASTENING PARTS.

62. Laying out Duplicate Parts.—Frequently a piece of work will require the making of two or more like parts. To lay out these parts, that is, to mark out the location of intended gains, mortises, shoulders of tenons, etc., so that

all shall be alike, the following method is used: (1) On the face edge of one of the pieces measure off with the rule and mark with knife the points at which the lines for the joints are to be squared across. If knife marks would show on the finished surface as scratches, use a sharp pencil instead. (2)



FIG. 117.

Lay the pieces on the bench top with the face edges up; even the ends with the try-square. Fig. 117. Square lines across the edges of all of them at the points previously marked on one of them. The pieces may then be separated and lines corresponding to the lines just made on the face edges, be carried across the face sides of each piece separately, the try-square beam being held against the face edge in so doing, of course.

In all duplicate work the aim of the worker should be to make as much use as possible of the tool he has in

hand before laying it down and taking another. To illustrate, if there should be a number of like parts, each requiring two different settings of the gage, he should mark all of the parts at the first setting, then all at the second setting, rather than to change the gage for each piece so that each piece might be completely marked before another is begun.

63. Scraping.—In smoothing hard wood surfaces, a scraper will be found helpful. If the grain should happen to be crossed or curled, a scraper will become a necessity. The plane-iron may be made ever so sharp and the cap-iron set ever so close to the cutting edge, still the surface of some woods will tear. Sandpaper must not be depended upon to smooth a torn surface.



FIG. 118.

Cabinet scrapers for plane and convex surface work are rectangular pieces of saw steel. Fig. 118 shows a swan-neck scraper suitable for smoothing concave surfaces.

Beginners frequently mistake surfaces which have been planed at a mill for smooth surfaces. They are not; and, unless the "hills and hollows" which extend across the surface of every mill-planed piece of lumber are removed before the finish of stain or filler is applied, the result will be very unsatisfactory.

These "hills and hollows" are present even in the smoothest of mill-planed surfaces. The reason is easily understood. When a board is mill-planed, it is run through a machine which has a flat bed over which the board is moved and above which revolve two knives. Fig. 119. Unless the grain of wood is very badly crossed or curled, it will be found very much easier, and time

will be saved, if the mill marks are removed with a smooth-plane before the scraper is applied.

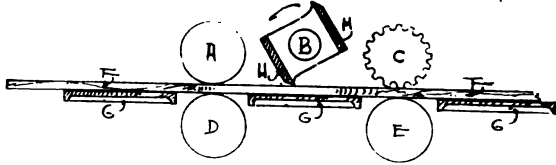

A-Delivery Roller. D-Roller. G-Work Table.
 B-Cutter Head. E-Roller. M-Knives.
 C-Feed Roller. F-Board.

FIG. 119.

Scrapers may be pushed or pulled. Fig. 120. When properly sharpened thin silky shavings will be cut off. The cutting edge of a scraper is a bur which is formed

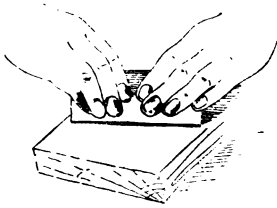

FIG. 120.

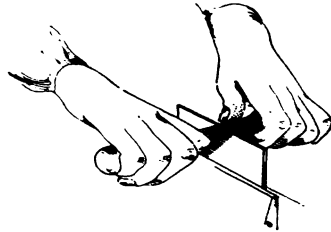

FIG. 121.

at an arris and turned at very nearly a right angle to the surface of the scraper.

When a scraper becomes dull (1) each edge is draw-filed, Fig. 121, so as to make it square and straight, with the corners slightly rounded. Sometimes the edges are rounded slightly from end to end to prevent digging. Frequently the scraper has its edges and surfaces ground

square on an oilstone after the draw-filing that the arrises may be formed into smoother burs. (2) After filing, the scraper is laid flat on the bench and the arrises forced over as in Fig. 122. The tool used is called a burnisher; any smooth piece of steel would do. (3) Next, turn these arrises back over the side of the scraper. Fig. 123. Great pressure is not necessary to form the burs properly.

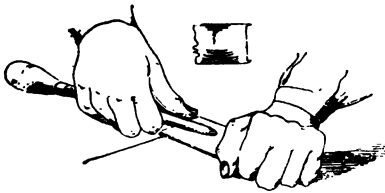

FIG. 122.

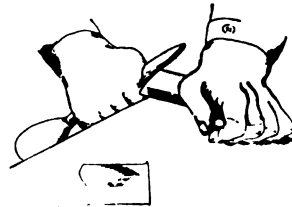
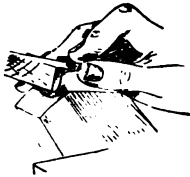

FIG. 123.

64. Sandpapering.—To know when to use and when not to use sandpaper is as much the sign of a good workman as to know how to use the tools.

Sandpaper should never be used until all tool work has been done as well and carried as far as is possible. Sandpaper is, as its name implies, sand paper. In sanding a surface, this fine sand becomes imbedded in the wood and should an edged tool be used thereon it will be dulled. Slovenly work should never be done in expectation of using sandpaper to fix it up. This practice is dishonest. Sandpaper should not be expected to do the work of edged tools or disappointment will follow. The sandpaper sheet, for use, is usually divided into four parts, one of these parts being of good size for large work.

For flat surfaces these pieces are placed on a sandpaper block. This block is merely a piece of wood squared up to a length equal to that of the piece of paper and to such a width that the edges of the paper will extend far enough up the edges of the block to allow the fingers to grasp them firmly. Fig. 124. Do not waste the paper by wrapping it around in such a way as to throw part of it on top of the block. The block should be held flat up-



on the surface when sanding near an arris, otherwise the arris will be rounded. The arrises should be kept sharp unless on a table leg, arm of a chair or something similar, in which the sharp arrises would be likely to injure the hand or become splintered through usage. In such cases the sandpaper may be run along the arrises once or twice, just enough to remove the sharpness. Sometimes the plane is set shallow and drawn over the arris after the surfaces have been squared, to remove the sharpness.

On curved surfaces, the sandpaper is held free in the hand, no block being used. Fig. 115 illustrates the manner of sanding the convex curve of the coat hanger. The sandpaper should be rubbed along the grain and the rubbing should proceed only long enough to smooth the piece and to bring out the grain clearly.

On the back of a piece of sandpaper will be found a number. This number indicates the relative coarseness of the sand sprinkled upon the glue covered paper. 00, 0, 1, 1½ and 2 are the numbers commonly used; 00 being finest and 2 relatively coarse. On table tops and surfaces which are not very smooth to begin with, the coarse

sandpaper is first used, this is followed by the next in coarseness and so on until the finest is used.

Never attempt to sandpaper surfaces or parts which are to be put together later on to form joints; the edge tools alone must be depended upon to secure proper smoothing.

65. Hammers.—Fig. 125 shows the two kinds of hammers most commonly used by workers in wood. The plain faced hammer has a flat face and is somewhat

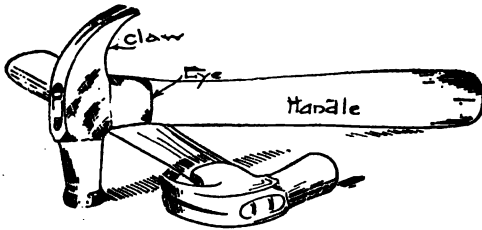

FIG. 125.

easier to learn to use than the bell-faced hammer, which has a slightly rounded face. The advantage of the bell-faced hammer

lies in one's ability to better set a nail slightly below the surface without the assistance of the nailset. This is a very great advantage on outside or on rough carpenter work. This setting of the nail with the hammer leaves a slight depression, however, in the wood, and is therefore not suited for inside finishing.

The handle of the hammer is purposely made quite long and should be grasped quite near the end.

66. Nails.—Nails originally were forged by hand and were therefore very expensive. Later strips were cut from sheets of metal and heads were hammered upon these by means of the blacksmith's hammer, the vise being used to hold the strips meanwhile. These were called cut nails. Early in the nineteenth century a machine was

invented which cut the nails from the sheet metal and headed them.

Steel wire nails have about supplanted the cut nails for most purposes. They are made by a machine which cuts the wire from a large reel, points and heads the pieces thus cut off.

Wire nails, like cut nails, are roughly classed by woodworkers as common, finishing and casing nails. Thin nails with small heads are called brads. Wire nails are bought and sold by weight, the size of wire according to the standard wire gage and the length in inches being taken into consideration in specifying the size and fixing the price per pound.

In former practice, the size of nails was specified according to the number of pounds that one thousand of any variety would weigh. Thus the term six-penny and eight-penny referred to varieties which would weigh six and eight pounds per thousand, respectively, penny being a corruption of pound. In present practice, certain sizes are still

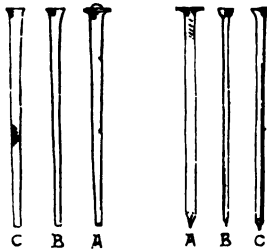

FIG. 126.

roughly specified as three, four, six, eight, ten, twenty and thirty-penny.

Common wire nails are thick and have large flat heads. They are used in rough work where strength is desired. Fig. 126A. Finishing nails, Fig. 126B, are used for fine work such as inside woodwork, cabinet work, etc. Casing nails, Fig. 126C, are somewhat thicker and stronger than finishing nails; they have small heads.

67. Nailing.—Especial care is necessary in starting cut nails. Fig. 127 shows two views of a cut nail. From

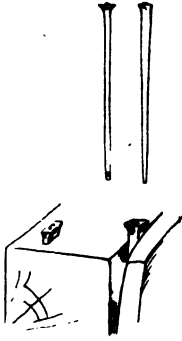

FIG. 127.

these it will be seen that the sides of the nail form a wedge in one of the views while in the other they are parallel. The nail should be so started that the wedging action shall take place along, not across the grain.

In nailing through one piece into the edge of another, assume a position so that you can look along the piece into the edge of which you are nailing. Fig. 128. If the nail is to be driven plumb, it must be sighted from two directions several times in the beginning of the nailing. Having driven the points of one or two of the nails slightly below the surface of the first piece, adjust the two pieces properly, force the points into the second piece, and, holding the parts firmly with the left hand, drive these nails into place. In starting a nail, place the board on a scrap of wood that the point shall not mark the bench top. Never try to change the direction of a nail after it has entered the wood by pounding it sidewise. This only bends the nail, does not change its direction but makes the point come out more quickly, if anything. Pull out the nail and start it in a new place. In nailing box



FIG. 128.

bottoms on before starting a nail look at the nails previously driven in the side pieces to see that your bottom nail will not strike one of these.

68. Nailset:—Except in rough work, the nail should not be driven entirely in with the hammer or the wood will be marred. A nailset held

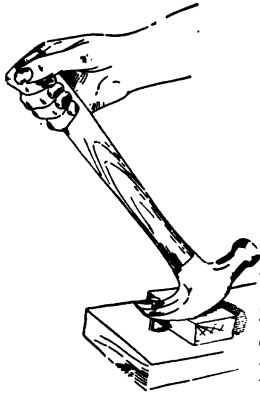

FIG. 130.

as in Fig. 129 should be used to set the head of the nail slightly below the surface of

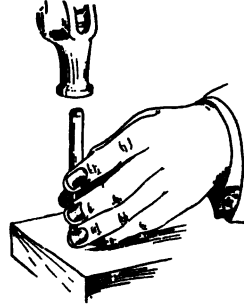

FIG. 129.

the wood—about one thirty-second of an inch. A finger placed against the side of the nailset and allowed to rest on the piece of wood aids greatly in guiding the set, which otherwise might jump off the nail head when the blow is struck and indent the wood.

69. Withdrawing Nails.—Should it be necessary to withdraw a nail, place a block of wood under the head of the hammer, Fig. 130, to prevent marring the surface of the wood. If the nail is a long one, the size of the block used should be increased as the nail comes out, that the nail may not be bent.



FIG. 131.

70. The Screwdriver—Patent ratchet and spiral screwdrivers have come into quite common use among workers

in wood. The old style, Fig. 131, however, is much better suited to elementary work than any of these special forms.

71. Screws.—Screws, like nails, are made entirely by machinery. They are packed in pasteboard boxes and sold by the gross. The size of a screw is designated by

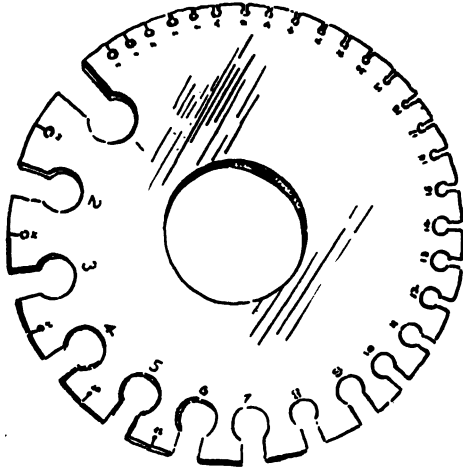

FIG. 132.

the length in inches and the size of the wire from which it is made; thus, 1 inch No. 10 flathead bright screw.

The gage of wire for nails and the gage of wire for screws should not be confused. Fig. 132 is a full-sized illustration of the gage used for determining the size of wire for nails. The numbers apply to the openings at the edge, not to the circular parts. The notch at No. 1 will just slip over No. 1 wire. Fig. 135 is a full-sized illustration of a wire gage for screws. The gage is slipped over the screw just below the head.

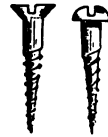

FIG. 133.

Flathead screws are used for ordinary work. Round-head screws are used because they are more ornamental. Fig. 133. Either kind may be made of steel or brass. Steel screws are often blued by treating them with heat or an acid.

72. Fastening with Screws.

—Where two pieces of hard wood are to be fastened with screws, a hole just large enough to take in the shank of the screw must be bored in the upper part. In the lower part, a hole should be bored just large enough to take in the core of the screw snugly. Fig. 134. For flathead screws, the hole should be countersunk so that the head may be flush or sunk slightly below the surface of the

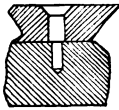

FIG. 134. omitted.

73. Glue.—Nails are but seldom used in cabinet work to fasten parts together, glue being used instead. Glue is manufactured from the refuse parts of animals. Strippings of hide, bone, horn, hoofs, etc., are boiled to a jelly; chemi-

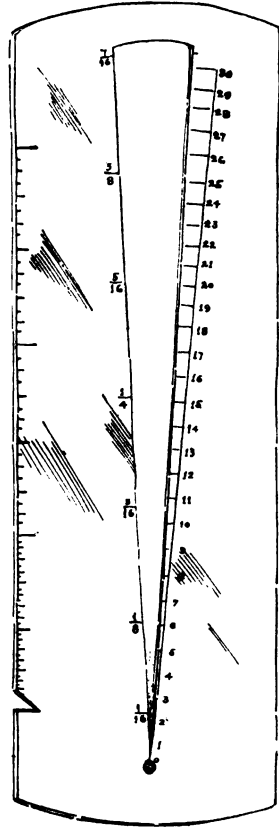

FIG. 135.

cals are added to give it the light color. It is usually placed on the market in the form of dry chips.

Glue pots are made double, the glue being placed in one part and this placed in a larger one which contains water.



FIG. 136.

The glue is heated by the hot water and steam of the outer kettle. Fig. 136.

To prepare glue, dissolve the dry chips in water. It is well to soak them over night unless quite thin. If the glue chips are thin they may be barely covered with water and the pot set in the outer kettle of boiling water. Some kinds of glue require less water. The glue should be stirred occasionally. It should be used while hot and should be made thin enough to flow easily when applied with a brush. If the wood is cold it will chill the glue. Best results are obtained by warming the wood in an oven.

Prepared liquid glues, to be applied without heating, are common. As these glues thicken with age, due to evaporation, they must be thinned occasionally. In cold weather they chill and must be warmed in hot water to bring them to a proper consistency.

74. Clamps.—Clamps are used in the making of a glue joint to expel the glue from the surfaces of contact, forcing it up into the pores of the wood or, if too much has been applied, out on the sides of the joint. For holding small parts, the wooden handscrew is used, Fig. 137. To adjust this clamp,

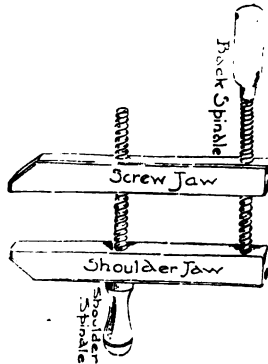

FIG. 137.

hold the handle of the shoulder spindle firmly in the left hand and the handle of the end spindle in the right hand; revolve them about an axis midway between and parallel to the spindles

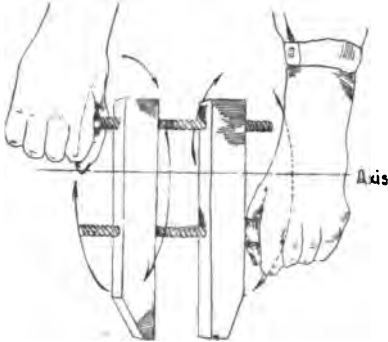

FIG. 138.

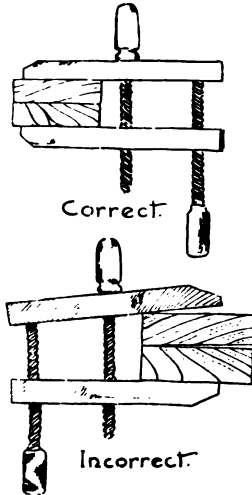

FIG. 139.

until the approximate opening of the jaw is obtained, Fig. 138. Place the clamp on the parts and screw the shoulder spindle up tight, adjusting the end spindle when necessary so that when it is tightened the jaws of the clamp shall be parallel, Fig. 139. In taking off this clamp, the end spindle is the one which must be released.

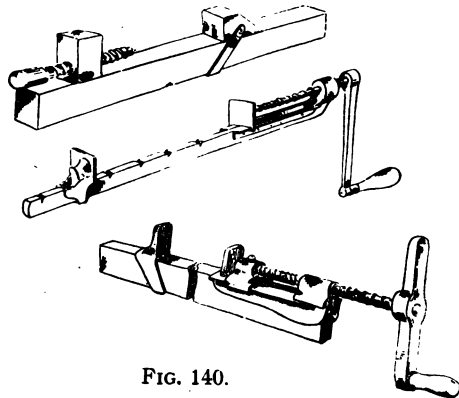

FIG. 140.

Fig. 140 illustrates three kinds of bar clamps such as are used for clamping wide frames and boards.

Fig. 141 illustrates a simple form of clamp which can be made by the student himself. Two wedges to each clamp, driven in with the hammer, supply the necessary

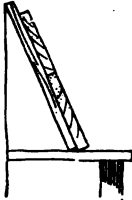
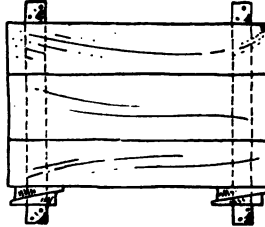

FIG. 142.

pressure. Whenever finished surfaces are to be clamped, blocks of wood must be placed between them and the clamp jaws to prevent their being marred.

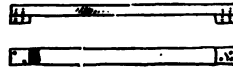

FIG. 141.

75. Gluing.—Where the end grain is to form part of a glue joint, it is necessary to apply a glue size first. This is done by filling the open grain of the end with a preliminary coating of thin, hot glue.

Rubbed glue joints require no clamps. The edges are jointed perfectly straight, glue is applied to each and they are then rubbed together with as great pressure as is possible to expel the glue. When this is properly done the pieces will hold together and may be set away to dry.

Fig. 142.

PART TWO.
SIMPLE JOINERY.

CHAPTER VIII.

TYPE FORMS.

76. Joinery.—This term in its broader meaning refers to the art of framing the finishing work of a house, such as doors and windows; and to the construction of permanent fittings, such as mantels, cupboards, linen presses, etc. Joinery as used herein refers merely to the putting together of two or more parts, called the members.

77. General Directions for Joinery.—Take into consideration the direction of the grain in planning the relative positions of the members. Make due allowance where shrinkage is likely to be considerable.

As far as possible, plan to have the members join face to face. Face sides are more likely to be true than are the other two surfaces and therefore the joints are more likely to fit properly.

Make all measurements from a common starting point, as far as practicable. Remember to keep the head of the gage and the beam of the try-square against one or the other of the faces, unless there should be special reasons for doing otherwise.

In practice it is sometimes advisable to locate the sides of a joint by superposition rather than by measurement.

Laying out by superposition consists in placing one member upon another and marking upon the second member the width, thickness or length of the first.

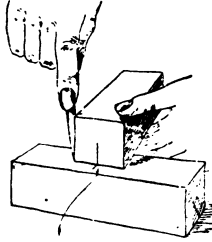

Center Lines
FIG. 143.

Usually, it is found possible to locate and square with knife and try-square a line to represent one of the sides of the joint. The first member is then held so that one of its arrises rests upon this line, and a point is made with knife at the other arris. The superimposed piece is then removed and a line made with knife and try-square—not thru the mark of the knife point but inside, just touching it. Fig. 143 illustrates locating with center lines.

Where several members or parts are to be laid out, cut and fitted, it is of the utmost importance that the work be done systematically. System and power to visualize—that is, to see things in their proper relation to one another in the finished piece—make it possible for men to lay out and cut the members of the most intricate frames of buildings before a single part has been put together. Lay out duplicate parts and duplicate joints as suggested in Chapter VII, Section 62. Where several joints of a similar size and kind are to be fitted, mark the different parts to each joint

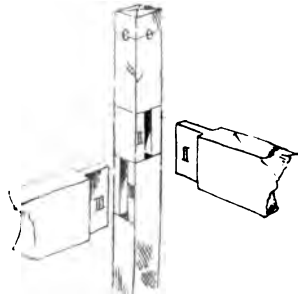

FIG. 144.

with the same number or letter as soon as fitted, that no other member may be fitted to either of these. Fig. 144.

On small pieces, such as the stool, it is possible to aid in visualizing by setting up the posts in the positions they are to occupy relative to one another, marking roughly, as with a penciled circle, the approximate location of the mortises, auger holes, etc. The members may then be laid on the bench and accurately marked without danger of misplacing the openings.

While the knife is used almost exclusively in laying out joints, there are a few instances in which a pencil, if well sharpened and used with slight pressure, is preferable. To illustrate, suppose it is desired to locate the ends of the mortises in the posts. Fig. 144. To knife entirely across the surfaces of the four pieces and around the sides of each, as would be necessary to locate the ends of the mortises, would injure the surfaces. Instead, pencil these lines and gage between the pencil lines. Those parts of the pencil lines enclosed by the gage lines—the ends of the mortises—may then be knifed, if desired, to assist in placing the chisel for the final cut.

In sawing joints in hard wood, the saw should be made to cut accurately to the line. Section 14, Fig. 32. When working soft wood, beginners are often permitted to leave a small margin—about one thirty-second of an inch—between the knife line and the saw kerf. This margin is afterward pared away with the chisel.

In assembling framework and the like, where it is necessary to drive the parts together, always place a block of wood upon the member to be pounded to take the indentations that will be made. A mallet is preferable to a hammer for such pounding.

78. Dado.—A dado, Fig. 145, is made by cutting a rectangular groove entirely across one member into which the end of another member fits. Dadoes are cut across the

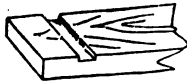

FIG. 145.

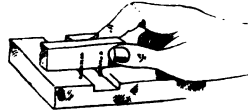

FIG. 146.

grain of the wood; when similar openings are cut parallel to the grain, they are called simply grooves. Dadoes are used in the making of shelving, window and door frames, etc.

79. Directions for Dado.—(1) Locate by means of the rule one side of the dado and mark its position with the point of the knife. (2) At this point, square a sharp line across the piece with knife and try-square. (3) By superposition, locate and mark the second side. (4) Square these lines across the edges of the piece a distance equal to the approximate depth of the dado. (5) Set the gage for the required depth and gage between the knife lines on the two edges. (6) Saw just far enough inside the knife lines that the sides of the dado may be finished to the lines with the chisel. Section 14, Fig. 33. Saw down just to the gage lines, watching both edges that the kerfs be not made too deep. (7) Chisel out the waste until the bottom of the dado is smooth and true. Chapter V, Section 47. Test the bottom as shown in Fig. 146. Two brads are driven into a block having a straight edge until they project a distance equal to the proposed depth of the dado. (8) Pare the sides of the dado to the knife lines. Chapter V, Section 48. These sides might be finished in

another way, by setting a wide chisel in the knife line and tapping it gently with a mallet. If care is taken the successive settings of the chisel need not show.

Where the dado is to be cut on a piece narrow enough that the saw may be made to follow the line accurately, it is considered better practice to saw accurately to the lines Section 14, Fig. 32.

80. Cross-lap Joint.—Usually, stock for the two members of the cross-lap joint can be best planed to width and thickness in one piece. Place two sets of face mark

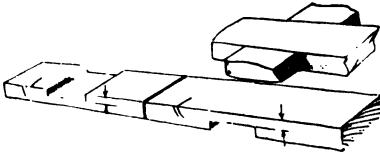

FIG. 147.

on the piece, so that there shall be one set of marks on each member after they are separated. Two methods of making this joint are given. The

first is safer for beginners; the second, because the members cannot be tried until the joints are completed, is an excellent test of one's ability. Fig. 147.

81. Directions for Cross-lap Joint.—*First Method:*

(1) Square the two ends, measure from each of these the desired length of each member, square knife lines around, saw apart, finishing the ends square to the lines. (2) Measure from one end of each member the required distance to the nearer edge of the joint. Since the corresponding faces of the two members must be on the same side of the piece when the parts are put together, it will be necessary to lay off the groove of one member on the face and of the other member on the side opposite the face. If the joints are to be in the middle of each member but one measurement need be made. Chapter VII, Section 62.

(3) Square sharp knife lines across at these points. (4) By superposition, locate and knife the second edge of each joint. (5) If the joints are to be in the middle of each member, before proceeding further, test to see that the

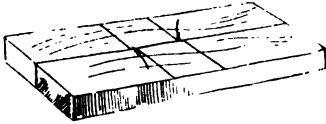

FIG. 148.

lines have been laid out properly. If the members are placed side by side and the ends evened as in laying out in (2) above, the lines will

of necessity correspond. Turn one of the members end for end and even the two ends; the lines ought still to correspond. If they do not, points marked midway between the corresponding lines will give the correct position for the new lines, Fig. 148. (6) Extend the knife lines across the two adjoining surfaces of each member. (7) Set the gage for the required depth and gage between the knife lines on the surfaces. Tho the groove on one mem-

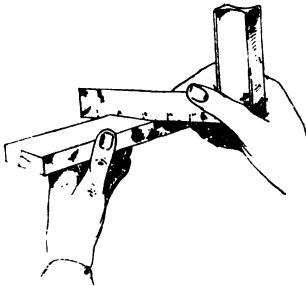

FIG. 149.

ber is laid out on the side opposite the face, do not make the mistake of holding the head of the gage against other than the

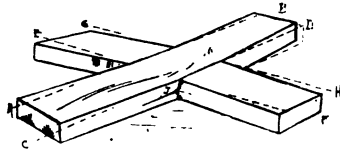

FIG. 150.

face. (8) Saw accurately, Section 14, Fig. 32, to the knife lines and to a depth indicated by the gage lines. (9) Chisel out the waste stock. Chapter V, Section 47. (10) Test as shown in Fig. 149. A well-made

cross-lap joint is one in which the members can be put together with the pressure of the hands and which will not fall apart of their own weight. Fig. 150 shows the results of "forcing a fit."

82. Directions for Cross-lap Joint.—*Second Method:*

The two members are to be planed to width and thickness in one piece but are not to be separated until the grooves have been laid out and cut. The grooves must be laid out by measurement only, since superposition is impossible. The positions of the grooves relative to the faces are, as in the first method, one on the face and one on the side opposite. The gaging for both is done from the faces.

83. Glue Joint.—Frequently it becomes necessary to glue together a number of boards to make one wide enough to meet the requirements of the work in hand. A table top is a good illustration. A properly glued butt joint ought to be stronger than the natural wood.

When the wood is of sufficient thickness, the joint may be reinforced by means of dowels. The jointer should be used for planing the edges. It is extremely difficult to prepare edges for glue joints with the shorter planes. The jack-plane should be used to rough off the edges and prepare them for the jointer.

84. Directions for Glue Joint.—(1) If the boards are in the rough, plane one surface of each true and out of wind. (2) Pencil the face marks upon these surfaces and indicate in some way the direction of the surface grain as well. Later, it will be necessary to plane both pieces at once in surfacing over the joints, and unless the parts are fitted with proper regard to the grain, it will be impossible to plane one without roughing up the other. Then, too,

the faces should be so selected that the warpage of one shall counteract the warpage of the other. Fig. 151 shows the manner of placing the pieces. Observe the rings of growth, Chapter 12. (3)



FIG. 151.

Joint one edge of each piece straight and square. The final plane strokes must be taken the full length of the board and the plane-iron must be set very shallow. Since the shrinkage is more at the ends than in the middle, sometimes the middles of long boards are planed just a shaving or two lower than the ends. (4) Place one of the

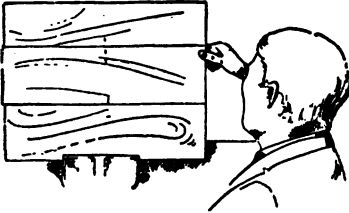

FIG. 152.

boards in the vise, jointed edge up, and place the other board in position on it. Four tests are commonly used: FIG. 153.



FIG. 153.

First, placing the eye on a level with the joint and looking toward the light, Fig. 152; second, tapping the under

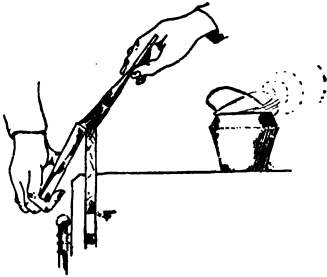

FIG. 154.

board lightly to see if the top board "rocks"; third, sliding the top board lengthwise slowly to "feel for suction"; fourth, holding a straight-

edge as shown in Fig. 153, to see that the faces lie in the same plane. (5) Glue the edges, Fig. 154. Work rapidly but carefully. (6) Place the parts in the clamps and

set away to dry; ten hours is usually long enough. Keep the faces as even as possible in applying the clamps. (7) When the glue has hardened the clamps may be removed, the surplus glue scraped off and the parts treated as one piece in squaring it up.

85. Doweling.—Dowels are small wooden pins used in joining parts together. Dowels can be bought ready made in a variety of sizes. If desired short dowels may be made as follows: (1) Select straight-grained strong wood—beech, birch or oak; waste wood can usually be found that will do. (2) Split, not saw, these pieces roughly to square prisms. The blocks from which they are to be split should not be over eight or ten inches long to work well.

(3) Plane off the irregularities, roughly rounding the pieces to size. (4) Point the ends slightly and drive the pieces thru a dowel plate. Fig. 155. The pegs should be driven thru the larger hole first. The holes of the dowel plate are larger in diameter on one side of the plate than on the other to give clearance to the peg as it is driven thru.

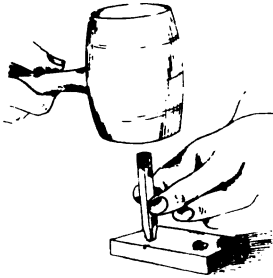

FIG. 155.

The cutting edge of the hole is at the smaller diameter; place that side of the plate up. Never use a hammer as it would split the top of the peg and would ruin the cutting edge of the dowel plate should it strike it. Use a mallet, and when the peg is nearly thru finish by striking a second peg placed upon the head of the first.

86. Directions for Doweling.—(1) Place the boards to be doweled side by side in the vise, the face sides out, and even the jointed edges. (2) Square lines across the two edges with knife and try-square at points where it is desired to locate dowels. (3) Set the gage for about half the thickness of the finished board and gage from the face side across knife lines. (4) At the resulting crosses bore holes of the same diameter as that of the dowel.

These holes should be bored to a uniform depth. Count the turns of the brace. One inch is a good depth for ordinary work. (5) Countersink the holes slightly, just enough to remove the sharp arrises. This removes any bur and allows a little space into which the surplus glue may run. (6) Cut the sharp arrises off the dowel, just enough

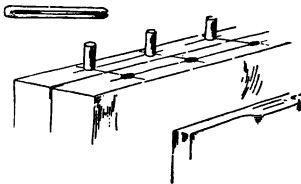

FIG. 156.

to allow it to be started into the hole. (7) With a stick slightly smaller than the hole, place glue upon the sides of the hole and drive the dowel in. A narrow saw kerf previously cut along the side of the dowel will

allow the surplus glue to escape and thus prevent any danger of splitting the board. (8) Clean off the surplus glue, unless the members can be placed together before it has had time to set. (9) Saw off the dowels to a length slightly less than the depth of the holes in the second piece. (10) Trim off the sharp arrises. Fig. 156. (11) Glue the holes and the edge of the second board. (12) Put the two members in the clamps and set away until the glue has had time to harden.

87. Keyed Tenon-and-Mortise.—Fig. 157 shows the tenon, the mortise in the second member into which the tenon fits, the mortise in the tenon and its key or wedge.

88. Directions for Keys.—Keys are made in quite a variety of shapes. Some of the simple forms are shown in Fig. 158. Where two or more keys of the same size are to be made, it is customary to plane all in one piece. (1) Plane a face side, a face edge, gage and plane to thickness. If there is more than one key, saw each to length. (2) Shape the remaining edge as desired. The

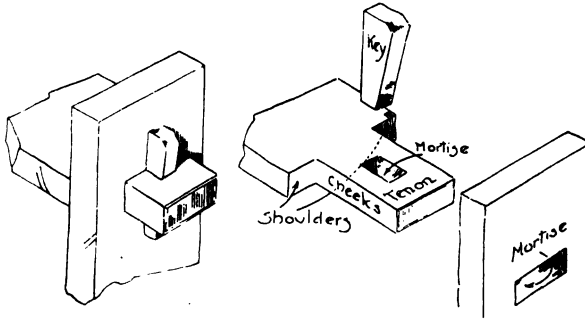

FIG. 157.

lines AB and CD, Fig. 158, indicate the points at which measurements are to be made to determine the length of mortise in the tenon which is to receive the key. These lines should be laid off at a distance apart equal to the thickness of the tenon.

89. Directions for Tenon.—(1) Measure from the end of the piece the length of the tenon, and mark with a knife point. Where tenons are to be cut on both ends of a piece, measurement is frequently made from the middle

of the piece each way to locate the shoulders. Should there be any variation in the length of the piece from what it should be, this difference will then be equally divided at the ends. This

is done when it is more important to have the distance between the shoulders of a definite length than that the tenons be of

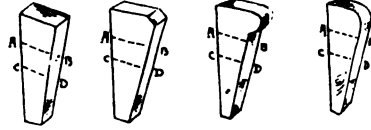

FIG. 158.

correct length. (2) Square knife lines entirely around the piece at the knife point mark. (3) Set the gage equal to the distance required from the face edge to the nearest edge of the tenon and mark on both sides, as far as the shoulder marks, and on the end. (4) Repeat, setting the

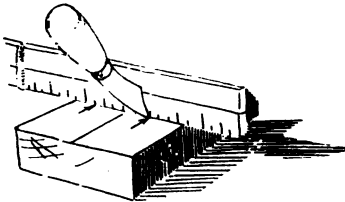

FIG. 159.



FIG. 160.

gage from the face edge to the farther edge of the tenon. If the two members are of the same width and the tenon and mortise are to be equally distant from the face edge, both tenon and mortise should be gaged with the same settings. Frequently the gage settings are obtained from the rule indirectly. The rule is laid across the piece and the width or thickness of mortise or tenon marked with the point of a knife blade, Fig. 159. The spur of the gage is then set in one of these points, the block being pushed firmly against the face; the thumb-screw is then fastened,

Fig. 160. The second setting is obtained in a similar manner from the same edge or side. All the pieces are marked for the first width before resetting. (5) After having laid out the mortise in the tenon, see (1), Sec. 91, rip to the gage lines and cross-cut to the shoulder lines, paring if necessary. (6) Slightly bevel the ends of the tenon.

90. Directions for Mortise.—(1) From one end of the piece measure and mark with the knife point the respective distances to the two edges of the mortise. (2) Square lines across the face edge and the two broad surfaces at these points. (3) Set the gage equal to the required distance from the face edge to the nearer edge of the mortise and mark between the lines. (4) Set the gage equal to the required distance from the face edge to the farther edge of the mortise and mark between the lines. Make both gage lines on face side and side opposite as well. (5) Cut the mortises. First, bore a series of holes thru the mortise, using a bit somewhat smaller than the width of the mortise. Bore these holes so that they connect one with another. (6) Place the

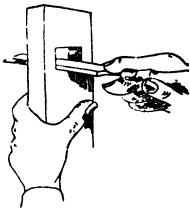

FIG. 161.

piece on a chiseling board and, taking thin cuts about half way thru, work from the middle of the mortise out to within one thirty-second of an inch of the knife and gage lines. (7) Reverse and chisel from the other side, finishing it; then chisel the first side out to the lines. Test the sides of the mortise with a straight-edge—the blade of the chisel makes a good one—to see that they are cut straight. Fig. 161.

91. Directions for Mortise in the Tenon.—(1) Lay out the sides of the mortise for the key before the sides and shoulders of the tenons are cut. From the shoulder line of the tenon, measure toward the end a distance slightly less—about one thirty-second of an inch—than the thickness of the member thru which the tenon is to pass. This is to insure the key's wedging against the second member. (2) Square this line across the face edge and on to the side opposite the face side. (3) On the top surface measure from the line just squared around the piece a distance equal to the width the key is to have at this point when in place, Fig. 158, AB. (4) Square a pencil line across the surface at this point. (5) In a similar manner, measure and locate a line on the opposite side, CD, Fig. 158. (6) Set the gage and mark the side of the mortise nearer the face edge on face side and side opposite. (7) Reset, and from the face edge gage the farther side of the mortise, marking both sides. (8) This mortise may be bored and chiseled like the one preceding. As one side of the mortise is to be cut sloping, a little more care will be needed.

92. Blind Mortise-and-Tenon.

—Probably no joint has a greater variety of applications than the blind mortise-and-tenon, Fig. 162. It is of equal importance to carpentry, joinery and cabinet-making. The tenon shown has four shoulders; it is often made with but three or two.

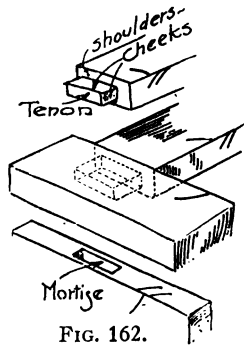

93. Directions for Tenon.—(1) Measure from the end of the piece the length of tenon, (see also directions for tenon, Section 89) and mark with the point of a knife. (2) Square knife lines entirely around the four sides at this point to locate the shoulders. (3) Lay the rule across the face edge near the end of the piece and mark points with the end of the knife to indicate the thickness of the tenon, Fig. 159. (4) With the head of the gage against the face side, set the spur of the gage in one of these marks, then fasten the set screw, Fig. 160. Gage on the end and the two edges as far back as the knife lines. When there are several tenons remember to mark all of them before resetting. (5) Set the gage in the other mark, the head of the gage being placed against the face side; then gage as before. (6) In a similar manner, place the rule across the face side, mark points with the knife for the width of tenon, set the gage to these points, and gage on the face and side opposite as far as the shoulder lines and across the end. The head of the gage must be held against the face edge for both settings. (7) Rip to all of the gage lines first, then cross-cut to the shoulder lines, using back-saw. (8) The end of the tenon may be slightly beveled that it may be started into the mortise without tearing off the arrises of the opening.

94. Directions for Laying out Mortise.—(1) From one end of the piece measure the required distance to the nearer and the farther ends of the mortise. Mark points with the knife. (2) Square lines across at these points. (3) Lay the rule across the face into which the mortise is to be cut and mark points with the knife for the sides of

the mortise. (4) Set the gage as was done for the tenon, the spur being placed in the knife point mark and the head of the gage being pushed up against the face. Gage between the cross lines. (5) Reset from the same face for the other side of the mortise, and then gage.

If a mortise or tenon is to be placed in the middle of a piece, find the middle of the piece, Fig. 3, Chapter I, Sec. 1, and with the knife, place points to each side of the center mark at a distance equal to one-half the thickness or width of the tenon or mortise. When several mortises or tenons of the same size are to be laid out and are to be equally distant from a face, the gage needs to be set but twice for all—once to mark the nearer edge and once for the farther edges of the tenon or mortise. Should there be several like members with like joints, the gage settings obtained from the first piece will suffice for all.

The importance of working from face sides or face edges only, cannot be overestimated. To work from either of the other two sides of a piece would make the joints subject to any variation in the widths or thicknesses of the pieces. To gage from the faces only, insures mortises and tenons of exact size no matter how much the pieces may vary in widths or thicknesses.

95. Directions for Cutting Mortise.—Two methods of cutting mortises are in common use, (a) boring and chiseling, and (b) chiseling alone. *First Method:* (1) Fasten the piece in the vise in a horizontal position. (2) Bore a series of connecting holes to the required depth, Chapter IV, Section 45, with a bit slightly smaller than the width of the mortise. (3) The sides of the mortise are next pared to the gage and knife lines, beginning at the

auger holes and working with thin slices toward the lines. This method requires care and patience in order to get the sides of the mortise cut square to the surface. It is especially well adapted to large mortises from which much wood is to be removed.

96. Directions for Cutting Mortise.—*Second Method:* (1) Clamp the piece which is to be mortised firmly to the bench top, using a hand clamp. Fig. 163 shows a little device called a mortise grip. Tighten the vise screw and tap the grip with the mallet until it holds the piece solidly. (2) Select a chisel of a width equal to that desired for the mortise. Stand well back of the mortise at one end or the other so as to be able to sight the chisel plumb with reference to the sides of the mortise. (3) Begin the cutting in the center of the mortise. Make the

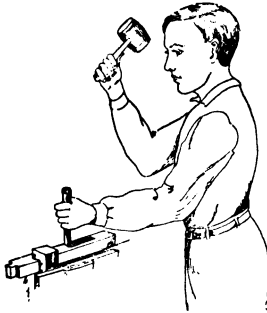

FIG. 163.

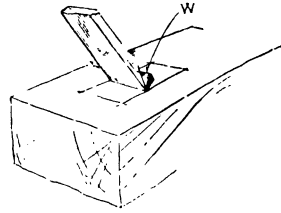

FIG. 164.

first cut with the bevel of the chisel toward you; reverse the bevel and cut out the wedge-shaped piece, w, Fig. 164. (4) Continue cutting in this manner until the proper depth has been attained, making the opening no larger at the surface than is necessary. (5) Set the chisel in a vertical position, bevel towards you, begin at the cen-

ter and, taking thin slices, cut toward the farther end. Drive the chisel the full depth of the mortise each time, then pull the handle towards you to break the chip from

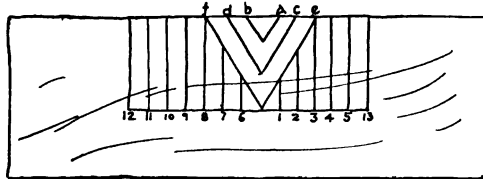

FIG. 165.

the sides of the mortise. Cut to within one-eighth of an inch of the end of the mortise. (6) Reverse the piece, or your position, and cut in a similar manner to within one-eighth of an inch of the second end. (7) With the bevel side of the chisel next the end of the mortise pry out the chips once or twice as the cutting proceeds. (8) Chisel the ends to the knife lines, carefully sighting the chisel for the two directions. Fig. 165 suggests the order.

97. Miter Joint.—The miter joint is subject to various modifications. In the plain miter, Fig. 166, the ends or edges abut. They are usually fastened with glue or nails or both. The most

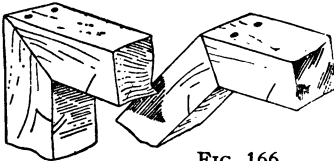

FIG. 166.

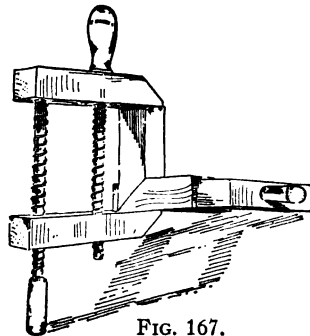

FIG. 167.

common form of the plain miter is that in which the slope is at an angle of forty-five degrees to the edge or side.

98. Directions for Miter Joint.—(1) Lay off the slopes (see Chapter 1, Section 4). (2) Cut and fit the parts. To fit and fasten four miter joints, such as are found in a picture frame, is no easy task. Special miter boxes are made for this purpose which make such work comparatively easy. (3) Fig. 167 shows the manner of applying the hand clamps to a simple miter joint. When a joint is to be nailed, drive the nail thru one piece until its point projects slightly. Place the second piece

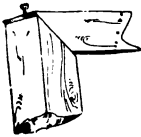

FIG. 168.

in the vise to hold it firmly. Hold the first piece so that its end projects somewhat over and beyond that of the second; the nailing will tend to bring it to its proper position, Fig. 168. If a nail is driven thru from the other direction, care must be taken to so place it that it will not strike the first, or a split joint will result.

99. Dovetail Joint.—Dovetailed joints are so named from the shape of the pieces which make the joint. Fig. 169 shows a thru multiple dovetail commonly used in fastening the corners of tool boxes. In hand-made dovetails, the tenons are very narrow and the mortises wide, while in machine-made dovetails, tenons and mortises are of equal width. Mechanics lay out the tenons without measurement, depending upon the

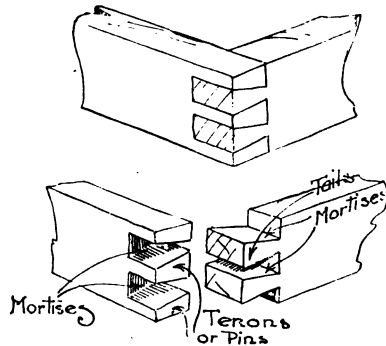

FIG. 169.

tenons and mortises are of equal width. Mechanics lay out the tenons without measurement, depending upon the

eye unaided to give the proper size and shape. Sometimes dovetails are laid out to exact shape and size, the tenons being marked on both sides and ends. The mortises are marked with try-square and bevel after one side of each has been marked by superimposing the tenons. In some kinds of dovetailing, such as the half-blind dovetail, the mortises are made first and the tenons marked out from them by superposition.

100. Directions for Dovetail Joint.—(1) Square lines around each end to locate the inner ends of the mortises and tenons. These lines will be at a distance from the ends equal to the respective thicknesses of the pieces. (2) Determine the number of tenons wanted and square center lines across the end of the member which is to have the tenons. Place these center lines so that the intervening spaces shall be equal. (3) Measure along an arris and mark on either side of these center lines one-half of the desired width of the tenon. In fine hand-made dovetails, the usual width for the narrow edge of tenon is scarcely more than one-sixteenth of an inch—the width of a narrow saw kerf. (4) Set the bevel for the amount of flare desired. Fig. 170 shows measurements which may be used in setting the bevel. A flare stick may be made of thin wood and used instead of a bevel if desired, Fig. 170. (5) Mark the flares on either side of the center lines. Place

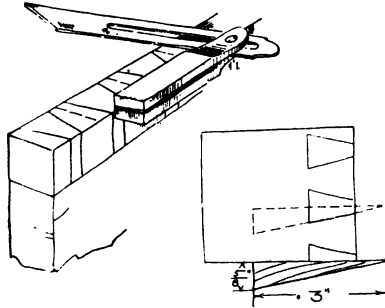

FIG. 170.

the bevel so that the wide side of the tenon shall be formed on the face side of the piece. (6) Carry these lines back on each side of the piece as far as the lines previously drawn across these sides. (7) With a fine tenon-saw rip accurately to the lines. Cut the kerfs out of the mortises, not out of the tenons. (8) Chisel out the mortises formed between the tenons and trim up any irregularities in the tenons. (9) Set the tenons on end on the face side of the second member, with the face side just touching the cross line placed on the

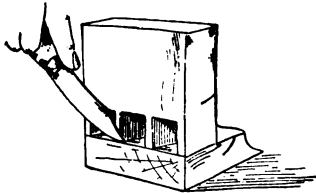

FIG. 171.

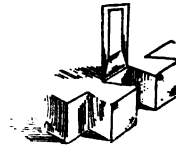

FIG. 172.

second member, Fig. 171, and mark along the sides of the tenons. (10) Square lines across the end to correspond with the lines just drawn. (11) Saw accurately to the lines, cutting the kerfs out of the mortises, not the tails. Chisel out the mortises for the tenons, Fig. 172. (12) Fit the parts together.

CHAPTER IX.

ELEMENTARY CABINET WORK.

101. Combination Plane.—The most elementary of cabinet work necessitates considerable groove cutting, rabbeting, etc. Rabbets and grooves can be formed by means of the chisel, the sides first being gaged. A better way, by far, is to plane them. In earlier practice, joiners were obliged to have a great variety of special planes—one for each kind of work, and frequently different planes



FIG. 173.

for different sizes of the same kind of work. There were rabbeting, dado, plow, filletster, beading, matching planes, etc.. etc.

Fig. 173 illustrates a modern combination plane which, by an exchange of cutters, can be made to do the work of a (1) beader, center beader, (2) rabbet and filletster, (3) dado, (4) plow, (5) matching plane, and (6) slitting plane, different sized cutters for each kind of work permitting of a great variety of uses. By means of a guide or fence, the plane can be set to cut to a required distance

from the edge of the board. A stop or depth gage can be set so as to keep the plane from cutting any deeper than is desired. When cutting across the grain, as in cutting dadoes, adjustable cutting spurs precede and score or cut the fibers of the wood on either side of the cutter.

102. Drawer Construction.—The front of a drawer is usually made of thicker stock than the other parts. Fig. 174. For example, if the front were to be made of three-quarter inch stock the sides, back and bottom would prob-

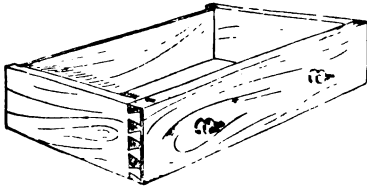

FIG. 174.

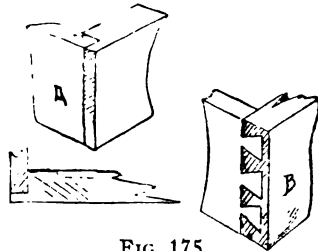

FIG. 175.

ably be made of three-eighths inch material. Drawer fronts are always made of the same material as the rest of the cabinet or desk while the sides, back and bottom are usually made of some soft wood such as yellow poplar.

Fig. 175A illustrates a very common method of fastening the drawer sides to the front. This form is used mainly upon cheap or rough construction. It is commonly known as a rabbeted joint. The half-blind dovetail, Fig. 175B, is a better fastening, by far, and is used almost exclusively on fine drawer construction.

103. Directions for Rabbeted Corner.—The rabbeted joint, Fig. 175A, sometimes called a rebate or ledge joint, is made as follows: (1) Line across the face side of the drawer front at a distance from the end equal to the

thickness of the drawer sides; also, across the edges to the approximate depth of rabbet. (2) Set the gage and gage on ends and edges as far as the lines just placed, for the depth of rabbet. (3) Cut the sides of rabbet, paring across the grain as in cutting the dado. Fasten by nailing thru the drawer sides into the front, not thru the front into the sides.

104. Directions for Dovetail Corner.—The front of the drawer should be laid out and cut first. (1) Gage on the end the distance the drawer side is to lap over the front. (2) Without changing the setting of the gage hold the head of the gage against the end of the drawer side and gage on both broad surfaces. Ordinarily, one should not gage across the grain of the wood nor should the head of the gage be held against other than a face. A little thought will show why exception has been made in this case. (3) Square a line across the face side—the inside surface—of the drawer front at a distance from the end equal to the thickness of the drawer side. This line gives the depth of mortise for the tails. (4) The groove for the drawer bottom having been cut, or its position marked on the end of the front, lay out on the end the half tenons at both edges so that the groove shall come wholly within a tail mortise. The amount of flare at which to set the bevel is given in Chapter VIII, Section 100. (5) Determine the number of tenons wanted and divide the space between the flares just drawn into the required number of equal parts and draw center lines for the tenons, Fig. 176. (6) With the bevel lay off to either side of these center lines the sides of the tenons. (7) Carry these lines down the face side to meet the line pre-

viously drawn to indicate mortise depth. (8) Saw exactly to the knife lines, cutting, Fig. 177, the kerfs out of

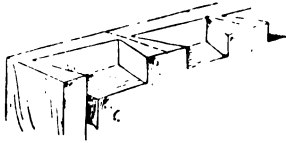

FIG. 176.

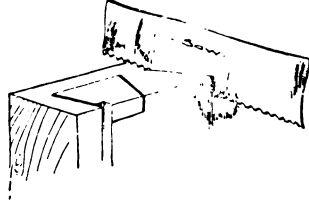

FIG. 177.

the mortises, not the tenons. (9) Chisel out the mortises, Fig. 178.

The corresponding mortises and tails may now be laid out on the drawer side and worked. (10) By superposition, Fig. 179, mark out the shape of the mortises to

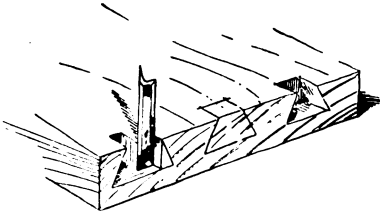

FIG. 178.

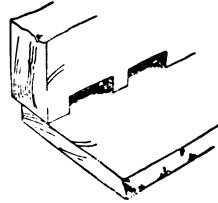

FIG. 179.

be cut in the sides. (11) Saw and chisel these mortises, Fig. 172.

105. Directions for Drawer.—(1) Square the different members to size. (2) Groove the front and sides of the drawer to receive the drawer bottom. These grooves should be made somewhat narrower than the bottom is thick to insure a good fit. The under side of the bottom, later, may be gaged and beveled on the two ends and the front edge, Fig. 180. (3) Lay out and cut in the drawer

sides the dados into which the ends of the back are to be fitted, Fig. 181. (4) Lay out and cut the joints on the front of the drawer. (5) Get the bottom ready; that is, plane the bevels on the under side as suggested in (2), above. (6) Assemble the members dry to see that all fit properly. (7) Take apart; glue the joints by which the sides are fastened to the front and the joints by which

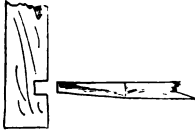

FIG. 180.

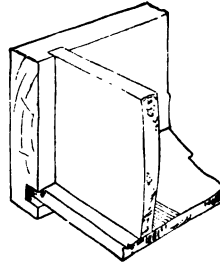

FIG. 181.

the back is fastened to the sides. Glue the bottom to the front of the drawer but not to the sides or back.

Sometimes on large or rough work nails are used instead of glue to fasten the members together. In this case the front, sides and back are put together, the back being kept just above the grooves in the sides. The bottom is then slipped in place under the back. It is fastened to the front of the drawer only. Especial care should be taken in squaring the bottom for the squareness of the drawer is dependent upon this.

106. Paneling.—Often it is desired to fill in a rather wide space with wood. To offset the effects of shrinkage, winding and warpage, a panel rather than a single solid piece is used. By increasing the number of panels a space of any size may be filled. Fig. 182.

In the making of doors, frames for panels, etc., enough extra stock must be added to the stiles and rails to permit their being trimmed when fitting them in place. One-quarter inch to each member is usual.

107. Cutting Grooves.—Grooves for panels are best cut by means of the panel plow or combination plane. It is not necessary to gage for the sides of the groove; the adjustments of the plane are such as to give the proper depth and location, when once set, and a cutter of the width equal to that of the desired groove inserted. The fence of the plane must be held against one or the other of the faces.



FIG. 182.

108. Haunched Mortise - and - Tenon.—A groove must be plowed the full length of a piece to work it to advantage. Where a mortise-and-tenon joint is to be made in which the grooved surface is to become a part, the tenon must be so cut as to allow its filling the groove.

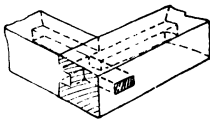

FIG. 183.

The mortise should be cut before the groove is plowed. The tenon, after being worked the full width, is gaged from the face edge to a width equal to the length of the mortise and worked to that size. Fig. 183.

Especial care must be taken in gluing up the frame that no glue shall get into the grooves or on the edges of the panel.

109. Rabbeting.—Fig. 184 shows a corner of a frame rabbeted to receive a glass. Rabbets are best worked with either a rabbet plane or the combination plane. In rabbeting across the grain the spur must be set parallel with the edges of the cutter.

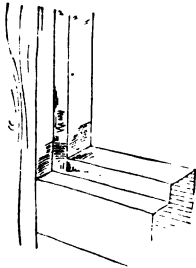

FIG. 184.

Since the parts of the frame are rabbeted the full length for convenience, a special joint is necessary at the corners. The mortises are cut before the rabbets are worked. The tenons are laid out so that the shoulder on one side shall extend

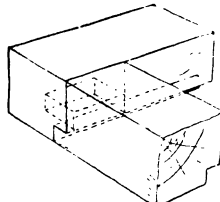

FIG. 185.

as far beyond the shoulder on the opposite side as the rabbet is deep. Fig. 185.

Where rabbeting must be worked with a chisel alone, Fig. 186 illustrates the manner of loosening up the wood preparatory to removing it, when the rabbet extends along the grain of the wood.

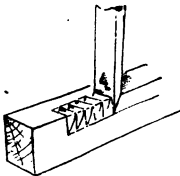

FIG. 186.

To place glass panels in rabbets, first place a slight cushion of putty in the rabbet that the glass may rest against it. A

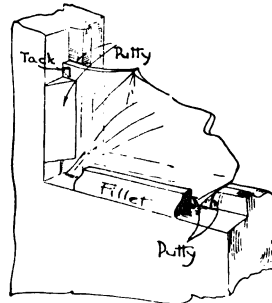

FIG. 187.

light cushion between the glass and the fillet will serve to

keep the glass from breaking and will keep it from rattling. Fig. 187.

110. Fitting a Door.—A door is a frame with a panel or a combination of panels. The names of the parts of a door and their relative positions are indicated in Fig. 188.

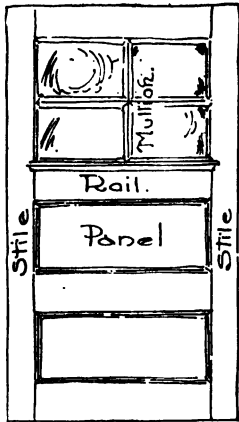

FIG. 188.

(1) Mark with a try-square and saw off the lugs, the parts of the stiles which project beyond the rails. (2) Plane an edge of the door until it fits a side of the frame against which it is to be hung. If the frame is straight, this edge may be planed straight. It is not wise to take for granted the squareness or straightness of a frame. A test or series of tests may first be made with square and straight-edge. A mechanic, however, usually planes an edge until it fits the frame, testing by holding the door against the frame as near to its position as its size will allow. (3) Plane the bottom or top edge of the door until it fits the frame properly when the first planed edge is in position. (4) Measure the width of the frame at its top and bottom, Fig. 189, and transfer these dimensions to the top and bottom of the door, connecting them with a straight-edge. When approaching the line, in planing, place the door against the frame often enough to see

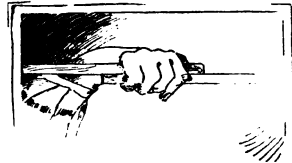

FIG. 189.

where the allowances must be made for irregularities in the frame. (5) The length of the frame may next be measured on each side and these dimensions transferred to the door. Connect them with a straight-edge and plane and fit as was directed in the third step.

A door to work well must not be fitted perfectly tight; it must have a little "play," the amount depending upon the size of the door.

The edge of the door which is to swing free is usually planed slightly lower at the back arris than at the front. An examination of the movement of an ordinary house door will show the reason for this.

111. Hinging a Door.—The hinges most commonly used in cabinet making and carpentry are the kind known as butts. Where the door stands in a vertical position, hinges in which the two parts are joined by a loose pin are generally used. By removing the pins the door may be removed without taking the screws out of the hinge. Such hinges are more easily applied than those with the fixed pin.

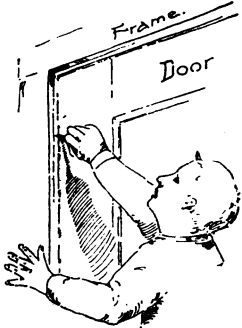

FIG. 190.

(1) Place the door in position; keep it tight against the top and the hinge side of the frame. (2) Measure from top and bottom of the door to locate the position for the top of the higher hinge and the bottom of the lower hinge. Usually, the lower hinge is placed somewhat farther from the bottom than the higher hinge is from the top. (3) With the knife or chisel mark on both door and frame at the points just located,

Fig. 190. (4) Take out the door, place the hinge as in Fig. 191, and mark along the ends with a knife. In a similar manner mark the frame. Make certain that the openings on door and on frame are laid off so as to correspond before proceeding further. (6) Set the gage for the depth the hinge is to be sunk and gage both door and frame. (7) Set another gage for width of openings and gage both door and frame, keeping the head of the gage against the front of the door. (8) Chisel out these gains on door and frame. (9) If loose-pin butts are used, separate the parts and fasten them in place.

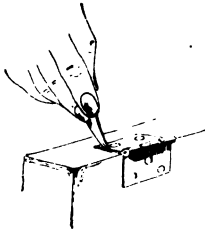

FIG. 191.

Use a brad awl to make openings for the screws. To insure the hinges' pulling tight against the side of the gain make the holes just a little nearer the back side of the screw hole of the hinge. Put the door in place and insert the pins. It is a good mechanic who can make a door hang properly the first time it is put up. It is better, therefore, to insert but one or two screws in each part of a hinge until the door has been tried. (10) If the door hangs away from the frame on the hinge side, take it off; take off hinge on door or frame, or both if the crack is large; chisel the gain deeper at its front. By chiseling at the front only and feathering the cut towards the back, the gain needs to be cut but about one-half as deep as if the whole hinge were sunk. If the door should fail to shut because the hinge edge strikes the frame too soon, the screws of the offending hinge must be loosened and a piece of heavy paper or

cardboard inserted along the entire edge of the gain. Fasten the screws and cut off the surplus paper with a knife. If plain butt hinges are used the operations are similar to those just described except that the whole hinge must be fastened to the door and the door held in place while fastening the hinges to the frame.

112. Locks.—Locks which are fastened upon the surface of a door are called rim locks. Those which are set

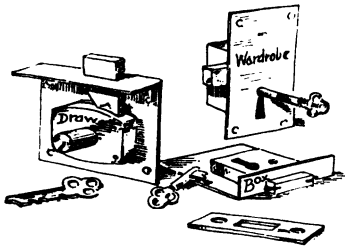

FIG. 192.

into mortises cut in the edge of the door are called mortise locks. Cabinet locks are placed somewhat above the middle of the door for convenience as well as appearance. Three styles of cabinet locks such as are used on drawers

and small boxes are shown in Fig. 192.

The manner of applying a cabinet lock will be suggested by the lock itself. On surface locks, (1) the lock is held against the inside of the door or drawer and the position of the keyhole is marked. (2) This hole is bored. (3) The lock is screwed in place, and (4) the escutcheon fastened to the outer or front surface. If a face-plate is used, the door is closed, the position marked, after which the door is opened and the plate is set. The face-plate is mortised into the frame so that its outer surface shall be slightly lower than that of the wood. With a lock such as the box lock, Fig. 192, sufficient wood must be removed from the mortise so that the bolt may act properly before the plate is screwed fast.

PART THREE.

WOOD AND WOOD FINISHING.

CHAPTER X.

WOOD.

113. Structure.—For convenience, tree structure is usually studied (1) in transverse or cross section, (2) radially, (3) tangentially.

A transverse section is obtained by cutting a log at right angles to its length; a radial section by cutting it along the radius; a tangential section by making a cut at right angles to a radius. Fig. 193.



V. Vessels or pores.
T.S. Tangential Section
C.S. Transverse " " "
R.S. Radial " " "

FIG. 193.

If we should cut transversely a young tree, a sprout, or branch of an oak or similar tree, we should find it composed

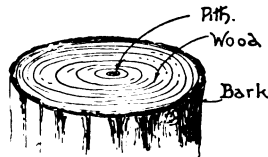

FIG. 194.

of three layers of tissue (1) pith or medulla, (2) wood, (3) bark, Fig. 194. These tissues, if magnified, would be found composed of little closed tubes or cells. Fig. 195.

Examine the end of a log cut from a tree such as the oak; we shall find that the center, which in the young

tree was soft, has become hard and dry, and that upon it are marked a series of concentric rings—rings having a common center. These rings are known as annual rings because one is added each year.

Usually, about three-quarters of the rings from the center outward will be found to have a different color from the remaining ones. These inner rings form what is called heartwood. The wood of the remaining rings will be found softer and to contain a larger proportion of sap. This part is called sapwood. Young trees are composed mainly of sapwood. As the tree grows older more of it is

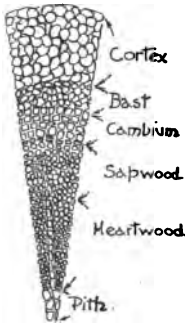

FIG. 195.

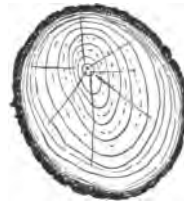

FIG. 196.

changed to heartwood, the heartwood becoming greater in proportion to the sapwood with age.

Upon examining these rings each will be found to be made up of two layers; one a light, soft, open, rapid growth formed in the spring, the other, a dark, hard, close, slow growth formed in the summer.

Frequently, the center of the annual rings is not in the center of the log. Fig. 196. This is due to the action of the sun in attracting more nourishment to one side than to the other.

Surrounding the sapwood is the bark. The inner part of the bark is called bast and is of a stringy or fibrous nature. Bark is largely dead matter formed from bast, Fig. 195. Its function is to protect the living tissues.

Between the bast and the last ring of the woody tissue is a thin layer called the cambium. This layer is the living and growing part of the tree. Its cells multiply by division and form new wood cells on the inside and new bast cells on the outside.

Heartwood is dead so far as any change in its cells is concerned. Its purpose is merely to stiffen and support the weight of the tree.

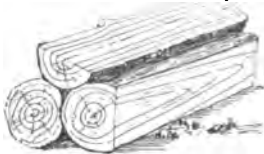

FIG. 197.

Sapwood, on the other hand, has many active cells which assist in the life processes of the tree, tho only in the outer layer of cells,

the cambium, does the actual growing or increasing process take place.

Again examining the end of the log, we shall find bright lines radiating from the center. They are composed of the same substance as the pith or medulla and are called pith or medullary rays. These rays are present in all trees which grow by adding ring upon ring but in some they are hardly visible. The purpose of these horizontal cells is to bind the vertical cells together and to assist in distributing and storing up plant food.

Fig. 197 shows a log cut longitudinally or lengthwise. The lines we call grain, it will be seen, are the edges of the annual rings, the light streaks being an edge view of

the spring layer and the dark streaks an edge view of the summer or autumn wood.

Knots are formed by the massing or knotting of the fibers of the tree through the growth of a branch. Fig. 198 shows the manner in which the fibers are turned. This packing of the fibers is what causes a knot to be so much harder than the rest of the wood.

114. Growth.—Sap is the life blood of the tree. In the winter when most of the trees are bare of leaves there is but very little circulation of the sap. The coming of spring, with its increase of heat and light, causes the tree



FIG. 198.

to begin to take on new life; that is, the sap begins to circulate. This movement of sap causes the roots to absorb from the soil certain elements such as hydrogen, oxygen, nitrogen and carbon, also mineral salts in solution. The liquid thus absorbed works its way upward, mainly by way of the sapwood and medullary cells. Upon reaching the cambium layer, the nourishment which it provides causes the cells to expand, divide and generate new cells. It also causes the buds to take the form of leaves.

When the sap reaches the leaves a chemical change takes place. This change takes place only in the presence of heat and light, and is caused by the action of a substance called chlorophyll. The importance of the work performed by chlorophyll cannot be overestimated. Nearly all plant life depends upon it to change mineral substance into food. Animals find food in plant life because of this change.

Assimilation is the process of taking up and breaking

up, by the leaves, of carbonic acid gas with which the cells containing chlorophyll come in contact. Carbon, one of the elements, is retained, but oxygen, the other element, is returned to the air. Carbon is combined with the oxygen and hydrogen of the water, which came up from the roots, to form new chemical compounds. Nitrogen and earthy parts, which came with the water, are also present.

Chlorophyll gives to leaves and young bark their green color.

The roots of the trees are constantly drinking plant food in the daytime of spring and early summer. From midsummer until the end of summer the amount of moisture taken in is very small so that the flow of sap almost ceases.

The leaves, however, are full of sap which, not being further thinned by the upward flow, becomes thickened thru the addition of carbonic acid gas and the loss of oxygen.

Toward the end of summer this thickened sap sinks to the under side of the leaf and gradually flows out of the leaf and down thru the bast of the branch and trunk, where another process of digestion takes place. One part of this descending sap which has been partly digested in the leaves and partly in the living tissues of root, trunk and branch, spreads over the wood formed in the spring and forms the summer wood. The second part is changed to bark. What is not used at once is stored until needed.

The leaves upon losing their sap change color, wither and drop off. By the end of autumn the downward flow

of changed sap from the leaves is completed and the tree has prepared itself for the coming winter.

It must be remembered that the foregoing changes are made gradually. After the first movement of the sap in the early spring has nourished the buds into leaves of a size sufficient to perform work, there begins a downward movement of food materials—slight at first, to be sure, but ever increasing in volume until the leaves are doing full duty. We may say, therefore, that the upward movement of the sap thru the sapwood and the downward flow of food materials thru the bast take place at the same time, their changes being of relative volumes rather than of time.

115. Respiration and Transpiration.—Plants, like animals, breathe; like animals they breathe in oxygen and breathe out carbonic acid gas. Respiration, which is but another name for breathing, goes on day and night, but is far less active than assimilation, which takes place only during the day. Consequently more carbonic acid gas is taken in than is given out except at night when, to a slight extent, the reverse takes place, small quantities of carbonic acid gas being given off and oxygen taken in.

Very small openings in the bark, called lenticels, furnish breathing places. Oxygen is also taken in thru the leaves.

Transpiration is the evaporation of water from all parts of the tree above ground, principally from the leaves.

The amount of water absorbed by the roots is greatly in excess of what is needed. That fresh supplies of earthy matter may reach the leaves, the excess of water must be got rid of. In trees with very thick bark, tran-

spiration takes place thru the lenticels in the bottom of the deep cracks.

116. Moisture.—Water is present in all wood. It may be found (1) in the cavities of the lifeless cells, fibers and vessels; (2) in the cell walls; and (3) in the living cells of which it forms over ninety per cent. Sapwood contains more water than heartwood.

Water-filled wood lacks the strength of wood from which the greater part of the moisture has been expelled by evaporation.

117. Shrinkage.—Water in the cell walls—it makes no difference whether the cells are filled or empty—causes

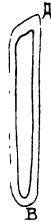

FIG. 199.



FIG. 200.

their enlargement and consequently an increase in the volume of the block or plank. The removal of this water by evaporation causes the walls to shrink; the plank becomes smaller and lighter. Thick walled cells shrink more than thin ones and summer wood more than spring wood. Cell walls do not shrink lengthwise and since the length of a cell is often a hundred or more times as great as its diameter the small shrinkage in the thickness of the cell walls at A and B, in Fig. 199, is not sufficient to make any noticeable change in the length of the timber.

Since the cells of the pith or medullary rays extend at right angles to the main body, Fig. 200, their smaller

shrinkage along the radius of the log opposes the shrinkage of the longitudinal fibers. This is one reason why a log shrinks more circumferentially, that is along the rings, than it does radially or along the radii. A second cause lies in the fact that greatly shrinking bands of summer wood are interrupted, along the radii, by as many bands of slower shrinking spring wood, while they are continuous along the rings.

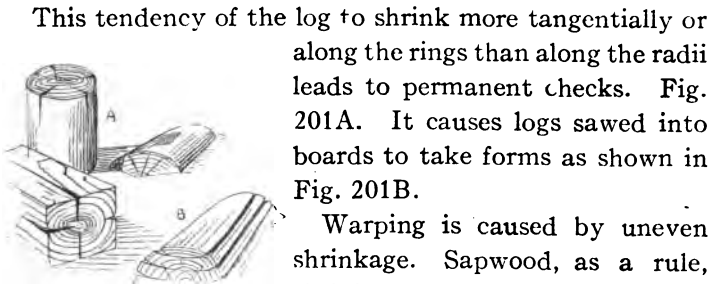

FIG. 201.

This tendency of the log to shrink more tangentially or along the rings than along the radii leads to permanent checks. Fig. 201A. It causes logs sawed into boards to take forms as shown in Fig. 201B.

Warping is caused by uneven shrinkage. Sapwood, as a rule, shrinks more than heartwood of the same weight. The wood of pine, spruce, cypress, etc., shrinks less than the wood of trees such as the oak.

118. Weight.—Wood substance is 1.6 times as heavy as water; it matters not whether it be wood of oak, pine or poplar. Wood placed in water floats because of the air enclosed in its cells; when the cells become filled with water it sinks.

The weight of any given piece of wood is determined (1) by the wood substance—this is always the same, (2) by the amount of water enclosed in its cells—this varies.

Some kinds of woods are heavier than others similarly seasoned because they contain more wood substance in a given volume.

Weight of wood is an important quality. To a large extent, strength is measured by weight; a heavy piece of oak will be stronger than a light one of the same species.

Lightness, strength and stiffness are properties which recommend wood for different uses.

119. Other Properties.—Strength, elasticity, hardness, toughness and cleavability, as applied to timber, have their usual meanings.

120. Grain.—Wood fibers generally extend parallel



FIG. 202.

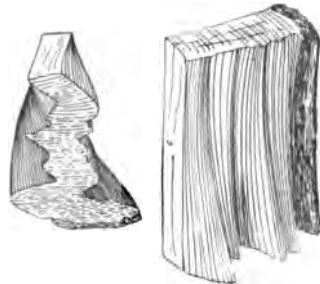

FIG. 203.

to the axis of the trunk or branch which they form. In this case the wood is said to be straight grained.

Frequently the fibers grow around the tree as in Fig. 202, or several layers may grow obliquely in one direction and the next series grow obliquely in the opposite direction, Fig. 203. Boards cut from such trees will be cross grained or twisted.

The surface of the wood under the bark is seldom smooth. Usually these hollows are filled even by the addition of one or two new rings of growth. However, in some woods as maple, the unevennesses are maintained,

the high places being added to as are the low. Fig. 204. Dormant buds frequently cause small cone-shaped elevations, which tho covered with successive layers of new



FIG. 204.

wood, retain their shape. Cross sections of these cones will appear in the sawed boards as irregular circles with a dark speck in the center, known as "birds' eyes."



FIG. 205.

FELLING RED SPRUCE WITH THE SAW. ADIRONDACK MOUNTAINS, NEW YORK.

CHAPTER XI.

LUMBERING AND MILLING.

121. Lumbering.—Lumbering is of two kinds: conservative and ordinary. The first seeks to so treat the forest that successive crops may be produced; the second takes no account of the future—it cuts only the better parts of the trees, often destroying young and promising trees in so doing.

Lumbering in the United States is usually carried on at quite a distance from habitation. A camp is, therefore, prepared at a spot convenient for the logging operators. Here the men eat and sleep.

A lumberman selects the trees which are to be cut and marks them with a hatchet to prevent mistakes.

These trees are felled either with the ax or saw, some-



FIG. 206.

HAULING SPRUCE LOGS TO THE SKIDWAY. ADIRONDACK MOUNTAINS, NEW YORK.

times both. Fig. 205. When the trees are down, the lower branches and top are trimmed off with axes, after which the trunks are sawed into logs of convenient length.

These logs are dragged away and collected in piles. This is called skidding, Fig. 206. Skidding is usually done with horses or oxen. From these piles the logs are loaded upon sleds, Fig. 207, and hauled to the place from which they are loaded on cars, rolled into a stream or otherwise transferred to the sawmill. Fig. 208 illustrates a method used in the south.

Logs are transported to the sawmill in various ways: They may be loaded on cars and hauled to the millpond, Figs. 209 and 210. They may be floated down some



FIG. 207.

LOAD OF WHITE PINE LOGS, HUBBARD CO., MINNESOTA.



FIG. 208.

HAULING LOGS BY MULE TEAM NEAR OCILLA, GEORGIA.

stream. Where a stream is not deep they are often collected in the bed just below a specially prepared dam called a splash-dam. When the dam is opened the sudden flood carries them along. Logs are often made into rafts where the stream is large and deep or they may be floated



FIG. 209.

LOADED TRAIN OF LONGLEAF PINE, BARHAM, LOUISIANA.

singly. Men called log or river drivers accompany these logs. It is their duty to break up any jams which the logs may form. River-driving is dangerous work and requires great daring on the part of the men. They must learn to balance themselves on floating, rolling logs.

When a log jam is broken the logs go out with a great rush and the driver must make his escape as best he can.

122. Milling.—If the sawmill is located upon the banks of a running stream the logs are enclosed by a log boom until they are wanted for sawing. Fig. 211. Log booms are made by chaining logs together and stretching them across the river; they are to the enclosed logs what fences are to cattle.

Soaking logs in water helps to clean the wood. The mineral matter which is soluble is washed out. Fig. 212.

Three kinds of saws are in common use in cutting logs into lumber: circular, band and gang. Circular saws cut faster than band-saws but are rather wasteful because



FIG. 210.

UNLOADING LOGS FROM TRAIN, PINOGRANDE, CALIFORNIA.

they cut such a wide kerf. A large circular saw frequently cuts a kerf one-quarter of an inch wide. Gang saws cut out several boards at the same time. Band-saws, because of their economy, are displacing the others.

The common forms into which logs are sawed are timbers, planks and boards. Timbers refer to the larger pieces such as are used for framing; planks are wide pieces over one and one-half inches thick; and boards are wide pieces one and one-half inches thick or less.

At the mill the log is drawn from the water, up a slide, Fig. 213, by an endless chain. In the mill it is inspected for stones and spikes and then measured. Next it is



FIG. 211.
THE GLENS FALLS BOOM, HUDSON RIVER, NEW YORK.



FIG. 212.
LOG POND NEAR OCILLA, GEORGIA.

The dogs are released and the log is given a half turn on the carriage by means of a steam "canter." The side from which the slab and boards were sawed is placed against the knees—the standards or uprights of the carriage—and the log again dogged. The opposite slab and a few more boards are sawed off after which the log is given a quarter turn and all but a few boards taken off.

A half turn of the log and the final sawings are made.

A series of "live" rolls—rolls which revolve in one direction—carry off the boards. The rough edged boards, which constitute about one-third of the whole number, are held by stops and finished on saws called edgers.

The boards are now passed on to a trimmer or jump saw and cut to standard lengths. Timbers are trimmed to length by a butting saw. Slabs are sawed to a length of four feet one inch on a slasher. These slabs are sawed into laths, pickets, or blocks the length of a shingle, called shingle bolts. From these bolts shingles are sawed.

123. Quarter Sawing.—Fig. 215 shows a common way of sawing "quarter-sawed" lumber.

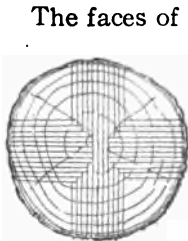

FIG. 215.

The faces of most of the boards are cut nearly parallel to the medullary rays, these rays come to the surface at small angles and make the beautiful spotting often seen in oak and sycamore. Quarter-sawed boards do not warp or twist as much as the plain sawed because the annual rings are perpendicular to the face.

124. Waste.—Attached to every sawmill will be found tower like structures from the tops of which smoke issues, Fig. 216. These are called burners and into them are



FIG. 213.
LOG SLIDE AT A MILL IN SOUTHERN GEORGIA.

When lumber reaches its destination it is sorted and graded according to lumbermen's standards, after which it is loaded upon trucks and hauled to the storage yards.

Here, it is so placed that air can get at the four sides of each piece and evaporate the water held by the "green" lumber. This is called air seasoning. The time necessary to season a piece of lumber so that it may be used for

high-grade work depends upon the kind of wood, its shape and size, the condition of the atmosphere, etc.

Two, three, and even four years are often required; the longer the better, provided it is kept dry.

It will never become perfectly dry because of the moisture in the



FIG. 217.

KILN-DRYING TUPELO, IONIA, MICHIGAN.

air itself. Because of the slowness of this method of seasoning, millmen resort to artificial means. The lumber, as it is needed, is shut up in a room heated by steam. Fig. 217 shows the method of "sticking" lumber in preparing it for the kiln.

High temperature, no matter how much moisture may be contained in the air, will evaporate water from wood.

Green, or fresh sapwood may be partially seasoned by boiling it in hot water or by steaming it.

Pine, spruce, cypress, cedar, etc., may be placed in the kiln as soon as sawed, four days for one inch thick boards

being sufficient to dry them. Hard woods, such as oak, maple, birch, etc., are usually allowed to "air season" for a period of from three to six months before being placed in the kiln. Six to ten days additional kiln-drying is allowed them.

The usual temperature for kilns is from 158 to 180 degrees Fahr. Hardwoods lose moisture so slowly that to place them in the kiln directly from the saw would cause them to shrink very unevenly and hence make them subject to serious "checks."

Lumber is frequently steamed to prevent its checking and "case hardening" while being kiln-dried.

127. Lumber Terms and Measurements.—"Clear" lumber is lumber which is free from knots and sapwood.

"Dressed" lumber or "surfaced" or "sized" lumber is lumber which has passed thru the planer.

The unit of measure is the board-foot which is one inch thick and twelve inches square or its equivalent. Boards less than one inch thick are sold by the square foot, face measure.

Shingles and lath are sold by the 1,000, the former being packed in bunches of 250 each and the latter in bundles of 50 each. Moldings are sold by "running" or lineal measure.

Prices are usually based upon the thousand feet; thus, 200 feet, 1st, clear, S2S, (sized or surfaced on two sides) at \$47 per M.

CHAPTER XII.

COMMON WOODS.

128. Classification.—According to botanical classification, woods belong to the Flowering Plants (Phanerogamia). Classified further we have:

- (1) Naked seeds (gymnosperms)
 1. Palm ferns, etc. (cycadaceæ)
 2. Joint firs (gnetaceæ)
 3. Pines, firs, etc. (conifers)
- (2) Fruits (angiosperms)
 1. One-seed-leaf (monocotyledons)
(Bamboos, palms, grasses, etc.)
 2. Two-seed-leaf (dicotyledon)
 - a. Herbs.
 - b. Broad-leaved trees.
(Oak, ash, elm, etc.)

Conifers and broad-leaved trees are alike in that they add a new layer of wood each year which covers the old wood of root, trunk and branch. They are known as exogens—outward growers.

In woods such as the palms, bamboos, and yuccas, growth is made from within.

The new wood strands mingle with the old and cause the cross sections to appear dotted, Fig. 218. Trees of

this class—endogens—after some years of growth form harder wood near the surface with younger and softer growth toward the center—quite the reverse of the exogens. There are no annual rings. Growth takes place mainly at the top.

Other classifications, such as deciduous, “hard woods,” “evergreens,” “soft woods,” are in common use but are not very accurate.

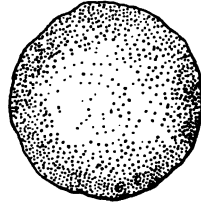

FIG. 218.

Deciduous trees are the broad-leaved trees and are so called because they lose their leaves in the fall. Broad-leaved trees are also called hard woods.

Conifers are called evergreens because their needle-shaped leaves remain green on the tree the year around. They are also known as soft woods.

Most of our timber is furnished by (1) the needle-leaved conifers and (2) the broad-leaved trees.

CONIFEROUS WOODS.¹

129. Cedar.—Fig. 219. Light, soft, stiff, not strong, of fine texture; sap and heartwood distinct, the former lighter, the latter a dull grayish brown, or red. The wood seasons rapidly, shrinks and checks but little, and is very durable. Used like soft pine, but owing to its great durability preferred for shingles, etc. Small sizes used for posts, ties, etc. (Since almost all kinds of wood are used for fuel and charcoal, and in the construction of fences, barns, etc., the enumeration of these uses has been omitted in this list.) Cedars usually oc-



FIG. 219

¹ The descriptive matter in small type is quoted, by permission, from a report of the Division of Forestry, U. S. Department of Agriculture, Washington, D. C.

cur scattered, but they form, in certain localities, forests of considerable extent.

130. Cypress.—Fig. 220. Cypress wood in appearance, quality, and uses is similar to white cedar. "Black cypress" and "white cypress" are heavy and light forms of the same species. The



FIG. 220.



FIG. 221.

cypress is a large deciduous tree occupying much of the swamp and overflow land along the coast and rivers of the Southern States.

131. Pine.—Fig. 221. Very variable, very light and soft in "soft" pine, such as white pine; of medium weight to heavy and quite hard in "hard" pine, of which longleaf or Georgia pine is the extreme form. Usually it is stiff, quite strong, of even texture, and more or less resinous. The sapwood is yellowish white; the heartwood, orange brown. Pine shrinks moderately, seasons rapidly and without much injury; it works easily; is never too hard to nail (unlike oak or hickory); it is mostly quite durable, and if well seasoned is not subject to the attacks of boring insects. The heavier the wood, the darker, stronger and harder it is, and the more it shrinks and checks. Pine is used more extensively than any other kind of wood. It is the principal wood in common carpentry, as well as in all heavy construction, bridges, trestles, etc. It is used also in almost every other wood industry, for spars, masts, planks, and timbers in ship building, in car and

wagon construction, in cooperage, for crates and boxes, in furniture work, for toys and patterns, railway ties, water pipes, excelsior, etc. Pines are usually large trees with few branches, the straight, cylindrical, useful stem forming by far the greatest part of the tree.

132. Spruce.—Fig. 222. Resembles soft pine, is light, very soft, stiff, moderately strong, less resinous than pine; has no distinct heartwood, and is of whitish color. Used like soft pine, but also employed as resonance wood and preferred for paper



FIG. 222.



FIG. 223.

pulp. Spruces, like pines, form extensive forests; they are more frugal, thrive on thinner soils, and bear more shade, but usually require a more humid climate. "Black" and "white" spruce, as applied by lumbermen, usually refer to narrow and wide ringed forms of black spruce.

BROAD-LEAVED WOODS.

133. Ash.—Fig. 223. Wood heavy, hard, strong, stiff, quite tough, not durable in contact with soil, straight grained, rough on the split surface and coarse in texture. The wood shrinks moderately, seasons with little injury, stands well and takes a good polish. In carpentry ash is used for finishing lumber, stairways, panels, etc.; it is used in shipbuilding, in the construc-

tion of cars, wagons, carriages, etc., in the manufacture of farm implements, machinery, and especially of furniture of all kinds, and also for harness work; for barrels, baskets, oars, tool handles, hoops, clothespins, and toys. The trees of the several species of ash are rapid growers, of small to medium height with stout trunks; they form no forests, but occur scattered in almost all broad-leaved forests.

134. **Basswood.**—Fig. 224. (Lime tree, American linden, lin, bee tree): Wood light, soft, stiff but not strong, of fine texture, and white to light brown color. The wood shrinks considerably in drying, works and stands well; it is used in carpentry, in the manufacture of furniture and woodenware, both turned and carved, in cooperage, for toys, also for paneling of car and carriage bodies. Medium to large sized trees, common in all Northern broad-leaved forests; found throughout the eastern United States.



FIG. 224.

found throughout the eastern United States.

135. **Birch.**—Fig. 225. Wood heavy, hard, strong, of fine



FIG. 225.



FIG. 226.

texture; sapwood whitish, heartwood in shades of brown with red and yellow; very handsome, with satiny luster, equaling

cherry. The wood shrinks considerably in drying, works and stands well and takes a good polish, but is not durable if exposed. Birch is used for finishing lumber in building, in the manufacture of furniture, in woodturnery for spools, boxes, wooden shoes, etc., for shoe lasts and pegs, for wagon hubs, ox yokes, etc., also in wood-carving. The birches are medium sized trees, form extensive forests northward and occur scattered in all broad-leaved forests of the eastern United States.

136. Butternut.—Fig. 226. (White Walnut.) Wood very similar to black walnut, but light, quite soft, not strong and of light brown color. Used chiefly for finishing lumber, cabinet work and cooperage. Medium sized tree, largest and most common in the Ohio basin; Maine to Minnesota and southward to Georgia and Alabama.



FIG. 227.

137. Cherry.—Fig. 227. Wood heavy, hard, strong, of fine texture; sapwood yellowish white, heartwood reddish to brown. The wood shrinks considerably in drying, works and stands well, takes a good polish, and is much esteemed for its beauty. Cherry is used chiefly as a decorative finishing lumber for buildings, cars and boats, also for furniture and for turnery. It is becoming too costly for many purposes for which it is naturally suited. The lumber-furnishing cherry of this country, the wild black cherry, is a small to medium sized tree, scattered through many

of the broad-leaved woods of the western slope of the Alleghanies, but found from Michigan to Florida and west to Texas.

- 138. Chestnut.**—Fig. 228. Wood light, moderately soft, stiff, not strong, of coarse texture; the sapwood light, the heartwood darker brown. It shrinks and checks considerably in drying, works easily, stands well, and is very durable. Used in cabinet work, cooperage, for railway ties, telegraph poles, and locally in heavy construction. Medium sized tree very common in the Alleghanies, occurs from Maine to Michigan



FIG. 228.

and southward to Alabama.

- 139. Elm.**—Fig. 229. Wood heavy, hard, strong, very tough; moderately durable in contact with the soil; commonly cross-grained, difficult to split and shape, warps and checks considerably in drying, but stands well if properly handled. The broad sapwood whitish, heart brown, both shades of gray



FIG. 229.

and red; on split surface rough, texture coarse to fine, capable of high polish. Elm is used in the construction of cars, wagons, etc., in boat and ship building, for agricultural implements and machinery; in rough cooperage, saddlery, and harness work, but particularly in the manufacture of all kinds of furniture, where the beautiful figures, especially of the tangential or bastard section, are just beginning to be duly appreciated. The elms are medium to large sized trees, of fairly rapid growth,

with stout trunk, form no forests of pure growth, but are found scattered in all the broad-leaved woods of our country.

140. Gum.—This general term refers to two kinds of wood, usually distinguished as sweet or red gum, and sour, black, or tupelo gum, the former being a relative of the witch-hazel, the latter belonging to the dogwood family.

Sweet Gum. Fig. 230. (red gum, liquidambar); Wood rather

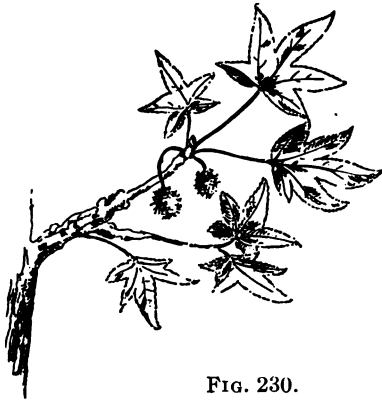

FIG. 230.

heavy, rather soft, quite stiff and strong, tough, commonly cross-grained, of fine texture; the broad sapwood whitish, the heartwood reddish brown; the wood warps and shrinks considerably, but does not check badly, stands well when fully seasoned, and takes good polish. Sweet gum is used in carpentry, in the manufacture of furniture, for cut veneer, for wooden plates, plaques,

baskets, etc., also for wagon hubs, hat blocks, etc. A large sized tree, very abundant, often the principal tree in the swampy parts of the bottoms of the Lower Mississippi Valley; occurs from New York to Texas and from Indiana to Florida.

141. Hickory—Fig 231. Wood very heavy, hard and strong, proverbially tough, of rather coarse texture, smooth and of straight grain. The board sapwood white, the heart reddish nut brown. It dries slowly, shrinks and checks considerably, is not durable in the ground, or if exposed, and, especially the sapwood, is always subject to



FIG. 231.

the inroads of boring insects. Hickory excels as carriage and wagon stock, but is also extensively used in the manufacture of implements and machinery, for tool handles, timber pins, for harness work and cooperage. The hickories are tall trees with slender stems, never form forests, occasionally small groves, but usually occur scattered among other broad-leaved trees in suitable localities.

142. Maple.—Fig. 232. Wood heavy, hard, strong, stiff, and



FIG. 232.

tough, of fine texture, frequently wavy grained, thus giving rise to "curly" and "blister" figures; not durable in the ground or otherwise exposed. Maple is creamy white, with shades of light brown in the heart; shrinks moderately, seasons, works and stands well, wears smoothly and takes fine polish. The wood is used for ceiling, flooring, paneling,

stairway and other finishing lumber in house, ship and car construction; it is used for the keels of boats and ships, in the manufacture of implements and machinery, but especially for furniture, where entire chamber sets of maple rival those of oak. Maple is also used for shoe lasts and other form blocks, for shoe pegs, for piano actions, school apparatus, for wood type in show bill printing, tool handles, wood carving, turnery and scroll work.

The maples are medium sized trees, of fairly rapid growth; sometimes form forests and frequently constitute a large proportion of the arborescent growth.

143. **Oak.**—Fig. 233. Wood very variable, usually very heavy and hard, very strong and tough, porous, and of coarse texture; the sapwood whitish, the heart "oak" brown to reddish brown. It shrinks and checks badly, giving trouble in seasoning, but stands well, is durable and little subject to attacks of insects. Oak is used for many purposes; in shipbuilding, for heavy construction, in common car-



FIG. 233.

penry, in furniture, car and wagon work, cooperage, turnery, and even in wood-carving; also in the manufacture of all kinds of farm implements, wooden mill machinery, for piles and wharves, railway ties, etc. The oaks are medium to large sized trees, forming the predominant part of a large portion of our broad-leaved forests, so that these are generally "oak forests" though they always contain a considerable proportion of other kinds of trees. Three well marked kinds, white, red, and live oak are distinguished and kept separate in the market. Of the two principal kinds, white oak is the stronger, tougher, less porous, and more durable. Red oak is usually of coarser texture, more porous, often brittle, less durable, and even more troublesome in seasoning than white oak. In carpentry and furniture work, red oak brings about the same price at present as white oak. The red oaks everywhere accompany the white oaks, and like the latter, are usually represented by several species in any given locality. Live oak, once largely employed in shipbuilding, possesses all the good qualities (except that of size) of the white oak, even to a greater degree. It is one of the heaviest, hardest and most durable building timbers of this country; in structure it resembles the red oak but is much less porous.

144. Sycamore.—Fig. 234 (button wood, button-ball tree, water beech): Wood moderately heavy, quite hard, stiff, strong, tough, usually cross-grained, of coarse texture, and white to light brown color; the wood is hard to split and work, shrinks moderately, warps and checks considerably but stands well. It is used extensively for drawers, backs, bottoms, etc., in cabinetwork, for tobacco boxes, in cooperage, and also for finishing lumber, where it has too long been underrated. A large tree, of rapid growth, common and largest in the Ohio and Mississippi valleys, at home in nearly all parts of the eastern United States.



FIG. 234.



FIG. 235.

145. Tulip Wood.—Fig. 235. Tulip tree. (yellow poplar, white wood): Wood quite variable in weight, usually light, soft, stiff but not strong, of fine texture, and yellowish color; the wood shrinks considerably, but seasons without much injury; works and stands remarkably well. Used for siding, for paneling, and finishing lumber in house, car and shipbuilding, for sideboards and panels of wagons and carriages; also in the manufacture of furniture, implements and machinery, for pump logs, and almost every kind of common woodenware, boxes, shelving, drawers, etc. An ideal wood for the carver and toy man. A large tree, does not form forests, but is quite common, especially in the Ohio basin; occurs from New England to Missouri and southward to Florida.

146. Walnut.—Fig. 236. Black walnut. Wood heavy, hard, strong, of coarse texture; the narrow sapwood whitish, the heartwood chocolate brown. The wood shrinks moderately in drying, works and stands well, takes a good polish, is quite handsome, and has been for a long time the favorite cabinet



FIG. 236.

wood in this country. Walnut formerly used even for fencing, has become too costly for ordinary uses, and is to-day employed largely as a veneer, for inside finish and cabinet work, also for turnery, for gunstocks, etc. Black walnut is a large tree, with stout trunk, of rapid growth, and was formerly quite abundant throughout the Alleghany region, occurring from New England to Texas, and from Michigan to Florida.

CHAPTER XIII.

WOOD FINISHING.

147. Wood Finishes.—Finishes are applied to wood surfaces (1) that the wood may be preserved, (2) that the appearance may be enhanced.

Finishing materials may be classed under one or the other of the following: Filler, stain, wax, varnish, oil, paint. These materials may be used singly upon a piece of wood or they may be combined in various ways to produce results desired.

148. Brushes.—Good brushes are made of bristles of

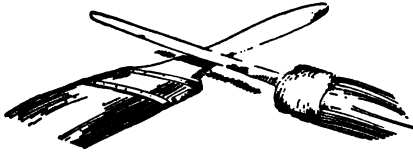

FIG. 237.

the wild boar of Russia and China. These bristles are set in cement and are firmly bound by being wrapped with wire in round brushes or enclosed in metal in flat brushes. Fig. 237.

A large brush, called a duster, is used for removing dust or loose dirt from the wood, Fig. 238. Small brushes, used for tracing, usually have chiseled edges, Fig. 239.

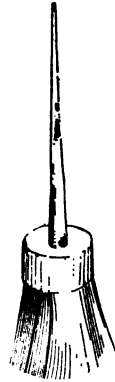

FIG. 238.

Bristle brushes are expensive and should be well cared for. Brushes that have been used in shellac and are not soon to be used again should be cleaned by rinsing them thoroughly in a cup of alcohol. This alcohol may be used later for thinning shellac.



FIG. 239.

Varnish and paint brushes should be cleaned in turpentine. If they are to be laid away for some time, a strong soap suds, or lather made from some of the soap powders, should be well worked into the brush, after the preliminary cleansing. It should then be carefully pressed into proper shape and laid way flat on a shelf. When the brush is to be used again, it should first be washed out, to get rid of all the soap.

Brushes that are used from day to day should be kept suspended, when not in use, as in Fig. 240, so that their bristles shall be kept moist, without their touching the bottom of the bucket or can.



FIG. 240.

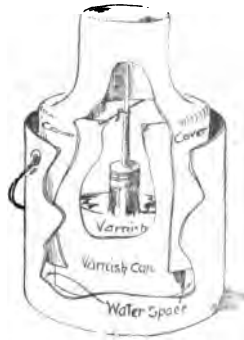

FIG. 241.

Since alcohol evaporates rapidly, shellac cans with cone tops should be used.

Fig. 241 shows a can which is made double. Varnish is kept in the inner portion and water in the outer ring.

The cover fits over the inner can and into the water space, thus sealing the varnish air-tight but removing all danger of the cover's sticking to the sides of the can. The brush is suspended from the "cleaning wire" so that its bristles rest in the liquid.

If delicate woods are to be varnished, stone or glass jars would better be used to hold the liquid, as metal discolours it slightly.

149. General Directions for Using Brush.—(1) Hold the brush as in Fig. 242. (2) Dip the end of the brush



FIG. 242.

in the liquid to about one-third the length of the bristles. (3) Wipe off the surplus liquid on the edge of the can, wiping both sides of the brush no more than is necessary to keep the liquid from dripping. A wire stretched across the can as in Fig. 243 provides a better wiping place for the dripping brush. In wiping the brush on the edge of the can, some of liquid is

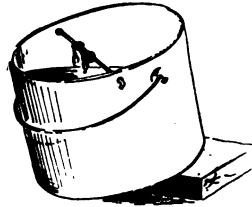

FIG. 243.

likely to "run" down the outside. (4) Using the end of the brush, apply the liquid near one end of the surface to be covered. (5) "Brush" in the direction of the grain. (6) Work towards and out over the end of the board, leveling the liquid to a smooth film of uniform thinness. The strokes should be "feathered", that is, the brush should be lowered gradually at the beginning of the sweep and raised gradually at the close, otherwise, ugly "laps" will result. The reason for working out over the ends rather

than from them will appear with a little thought. (7) Now work toward the second end. The arrows, Fig. 244, show the general directions of the final or feathering strokes.

Edges are usually covered first and adjoining surfaces afterward.

It frequently happens that surplus liquid runs over a finished surface, especially when working near the arrises. This surplus can be "picked up" by wiping the brush up-

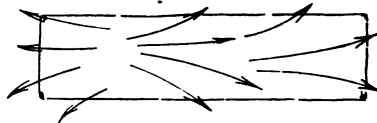

FIG. 244.

on the wire of the bucket until the bristles are quite free of liquid, and giving the part affected a feathering sweep.

If the object has an internal corner, work from that out over the neighboring surfaces.

Panels and sunk places should be covered first. Afterward, the raised places, such as stiles, rails, etc., may be attended to. Wherever possible the work should be laid flat so that the liquid may be flowed on horizontally. This is of especial advantage in varnishing. Vertical work should always be begun at the top and carried downward.

Tracing consists in working a liquid up to a given line but not over it, such as painting the sash of a window. Tracing requires a steady hand and some practice. A small brush is generally used and the stroke is made as nearly continuous as the flow of the liquid will allow. Fig. 245.

150. Fillers.—Fillers are of two kinds, paste and liquid. They are used to fill up the wood pores and thus give a smooth, level, non-absorbent surface, upon which other coverings may be placed. Paste fillers are for use upon coarse grained woods such as oak and chestnut, while liquid fillers are for close grained woods such as Georgia pine.



FIG. 245.

Fillers are not a necessity, especially the liquid, but the saving effected by their use is considerable. Not only are they cheaper than varnish but one or two coats of filler will take the place and permit a saving of two or three coats of the more expensive material.

Liquid filler should be applied evenly with a brush and allowed to dry twenty-four hours, after which it may be sanded smooth with No. 00 paper. It is used mainly upon large work such as porch ceilings and interior finish, like Georgia pine. On fine cabinet work, one or two coats of thin white shellac is used as a filler upon close grained wood. Shellac forms a surface which, after twenty-four hours, can be sandpapered so as to make a very smooth surface. Varnish applied to the bare wood has a tendency to darken and discolor it. Filling with shellac preserves the natural color.

Paste filler is sold by the pound in cans of various sizes. The best fillers are made of ground rock crystal mixed with raw linseed oil, japan and turpentine.

For preserving the natural color of the wood, filler is left white; for Flemish, it is colored brown; for antique

and weathered finishes, it is dark. Fillers can be purchased ready colored.

151. Filling with Paste Filler.—(1) Thin the filler with turpentine until it makes a thin paste. (2) With a stiff-bristled brush, force the filler into the pores of the wood and leave the surface covered with a thin coating. (3) Allow this to stand until the filler has “flatted,” that is, until the “gloss” has disappeared and the filler becomes dull and chalkish. The time required for this to take place varies. Twenty minutes is not unusual. (4) Rub the filler off just as soon as it has flatted—do not let it stand longer, for the longer it stands the harder it is to remove. Rub across the grain as much as is possible, using a wad of excelsior. Finish fine work by going over it a second time with a cloth, rubbing with the grain as well as across, that the “high lights” may be clear of filler.

On fine work use a felt pad to rub the filler into the pores, and rub off with a cloth only.

Twenty-four hours should be allowed the filler to harden. One filling is sufficient for ordinary work; on fine work the above process is sometimes repeated after the first filling has hardened.

The striking contrasts in the grain of wood such as oak and chestnut, obtained by the use of colored fillers, are due to the dark filler's remaining in the open grain but being wiped off of the close grain—the “high lights.”

On quarter-sawed oak, each flake is sometimes sanded with fine paper, No. 00, to remove the stain that the contrast may be sharper.

Excelsior and rags used in cleaning off filler must not be allowed to lie around, but must be burned, as they are subject to spontaneous combustion and are dangerous.

152. Stains.—Stains are used to darken the high lights of wood preparatory to the application of a relatively darker filler. By varying the intensity of the stain different results may be obtained with the same color of filler. Stains are also used without fillers.

There are three kinds of stains: (1) water, (2) oil, (3) spirit. Each kind has its advantages and its disadvantages.

Water stains are cheap, penetrate the wood deeply, and are transparent. They cause the grain of the wood to "rough up," however, and for this reason are used mainly upon hard woods which require darkening before the application of a filler. The wood is sanded before the filler is applied. Where water stain is not to be followed by filler, it is customary to thoroughly moisten the surface to be covered with water alone. After this has dried, the surface is sanded with fine paper and the stain applied. The stain does not raise the grain as it otherwise would.

Water stains may be applied with a brush or a sponge. They are sometimes heated that they may enter the wood more deeply. Any coloring matter that can be dissolved in water will make a wood dye or stain.

Oil stains, like water stains, are often used to stain wood before filling. They are more generally used where no filling is desired. They are easier to apply evenly than water or spirit stains. They do not raise the grain of the wood like the other stains. On the other hand, they

do not penetrate and therefore cannot color hard woods dark. Neither do they give the clear effects.

Most oil stains are applied with a brush, after which the surface of the wood is immediately wiped clean with a cloth.

Spirit stains are but little used where surfaces of any size are to be covered. They are expensive, fade easily, and are hard to apply evenly.

They are applied with a brush and dry very quickly.

A stain which penetrates deeply and is clear is obtained by placing the wood in a closed receptacle in which is placed a dish of concentrated ammonia. The fumes of this liquid cause a chemical change to take place, giving to the wood a rich nut-brown color.

153. Waxing.—An old finish that has recently become popular is that of waxing. It takes the place of the varnish, by which it was supplanted years ago.

Wax finish is easily applied and is cheaper than varnish. It will not stand wetting. However, it is easily repaired.

Our ancestors used to make wax polish by "cutting" beeswax with turpentine.

Rapid drying and hardening waxes can be purchased now-a-days. They require a smooth surface and a very thin application for a successful result. Too much wax upon a rough surface will produce very ugly, white, chalk-like spottings as the wax dries. These are especially noticeable upon dark finishes. Waxes colored black overcome this but are not needed if the ordinary wax is properly applied.

In finishing with wax the following directions may be

followed: (1) Stain the wood if a very dark finish is desired. (2) If the wood is coarse-grained, put on two coats of paste filler and rub it off carefully, that a smooth surface may be prepared. Allow the stain twelve hours in which to dry, also each coat of the filler. (3) With a soft cloth apply as thin a coating of wax as can be and yet cover the wood. Wax is in paste form. (4) Allow this to stand five or ten minutes, then rub briskly with a soft dry cloth to polish. (5) After this coat has stood for one hour another may be applied in the same manner.

A thin coat of shellac brushed evenly upon the hardened filler "brings out" the grain and makes an excellent base for wax as well as varnish. It should stand twenty-four hours and then be sanded smooth with No. 00 sandpaper before the wax is applied.

There are other patent preparations which give the same soft effects as wax and are as easily applied—in fact, some of them are but wax in liquid form.

154. Varnishes.—Varnishes are used where a hard, transparent coating is desired. There are two kinds, (1) shellac or spirit varnish, (2) copal or oil varnish.

Varnishes vary greatly in quality and therefore in price. If made of specially selected pale gum for use on light or white woods the price will be higher than for that of ordinary color tho the quality may be no higher.

Rubbing varnishes are so made that they may take a "rubbed finish."

Varnishing should be done in a room in which the temperature can be kept from 70 to 80 degrees Fahr., and which is comparatively free from dust. The surface to be covered must be clean, dry and filled even and smooth.

155. Shellac.—Shellac or spirit varnish is a solution of lac and alcohol. Lac is soluble in both grain and wood alcohol but grain alcohol is preferable. Beds of crude lac are found in parts of Africa and South America where the lac has been left by the decay of leaves and twigs which it at one time encrusted. Crude lac is deposited upon leaves and twigs of certain of the lac-bearing trees by countless numbers of insects which draw out the sap.

Stick-lac is crude lac which has been purified somewhat of the bodies and eggs of the insects and rolled into stick forms. When crushed and washed it is known as seed-lac. When fully purified, which is done by melting and straining, it is spread out and is known as shellac.

White shellac is obtained by bleaching. Orange shellac is unbleached. Pure white shellac is used where the more yellow shellac would discolor. Orange shellac is stronger than white and will last longer but is harder to apply because it sets more rapidly.

Shellac varnish sets quickly, dries hard but softens under moisture. Unlike oil varnish, it does not "level up" and must, therefore, be brushed on quickly, using long, even strokes. No spots must be omitted for they cannot be "touched up."

156. Shellac Finishes.—The use of one or more coats of shellac preparatory to a varnish finish has been noted.

A very simple finish, and one that is easily applied, is obtained by covering stained wood with a very thin coat of shellac.

To obtain the finish known as egg-shell gloss, (1) Coat the smooth wood with from three to six applications of thin shellac. Allow each coat twenty-four hours in which

to harden. (2) Rub to a smooth surface each hardened coat, using curled hair or fine steel wool or fine oiled sand-paper.

157. Oil or Copal Varnishes.—Oil varnish is composed of copal gum, boiled oil and turpentine. Copal gums are obtained from Africa mainly, in certain parts of which they are found as fossil resins, the remains of forests which once covered the ground.

Pressed flaxseed furnishes crude linseed oil while the long leaf pine of the South furnishes the turpentine pitch.

The oil is prepared for use by boiling it in huge kettles with different materials which cause it to change chemically. It is then put away to settle and age, that is to clear and purify itself. It takes from one to six months for the oil to reach a proper degree of clearness and purity. Turpentine is obtained from its pitch by distillation.

The copal gums are melted and boiled thoroly with the oil. Turpentine is added after the mixture of gum and oil has cooled sufficiently. The whole is then strained several times, placed in tanks to age or ripen. From one month to a year, or even more, is required.

The quality of varnish depends upon the qualities of the gums, the proportion of oil and turpentine and the care which is exercised in the boiling process.

158. Flowing Copal Varnish.—(1) Lay on the varnish quickly in a good heavy coat. Use a good varnish brush and dip the bristles deeply into the liquid, wiping them off just enough to prevent dripping. (2) Wipe the bristles quite free of varnish; go over the surface and pick up as much of the surplus liquid as the brush will hold. Replace the varnish in the can by wiping the

bristles on the wire of the can. Repeat until the entire surface has been left with but a thin smooth coating.

Two, three, four or more coats are applied in this manner, forty-eight hours being allowed between each for drying. Dry varnish comes off in sanding as a white powder; if not dry it will come off on the sandpaper as little black spots.

159. Typical Finishes for Coarse-grained Woods.

—Egg-shell gloss: (1) One coat of water stain, English golden, etc., according to the result desired. (2) Allow time to dry, then sandpaper lightly with fine sandpaper. This is to smooth the grain and to bring up the high-lights by removing stain from some of the wood. Use No. 00 sandpaper and hold it on the finger tips. (3) Apply a second coat of the stain diluted about one-half with water. This will throw the grain into still higher relief and thus produce a still greater contrast. Apply this coat of stain very sparingly, using a rag. Should this stain raise the grain, again rub lightly with fine worn sandpaper, just enough to smooth. (4) When this has dried, put on a light coat of thin shellac. Shellac precedes filling that it may prevent the high lights—the solid parts of wood—from being discolored by the stain in the filler, thus causing a muddy effect. The shellac being thin does not interfere with the filler's entering the pores of the open grain. (5) Sand lightly with fine sandpaper. (6) Fill with paste filler colored to match the stain. (7) Cover this with a coat of orange shellac. This coat of shellac might be omitted but another coat of varnish must be added. (8) Sandpaper lightly. (9) Apply two or three coats of varnish. (10) Rub the first coats

with hair cloth or curled hair and the last with pulverized pumice stone and crude oil or raw linseed oil.

Dull finish: A dead surface is obtained by rubbing the varnish, after it has become bone dry, with powdered pumice stone and water, using a piece of rubbing felt. Rub until the surface is smooth and even, being careful not to cut thru by rubbing too long at any one spot. The edges are most likely to be endangered. Use a wet sponge and chamois skin to clean off the pumice.

Polished finish: The last coat should be rubbed first with pulverized pumice stone and water, and then with rotten stone and water. For a piano finish rub further with a mixture of oil and a little pulverized rotten stone, using a soft felt or flannel. A rotary motion is generally used and the mixture is often rubbed with the bare hand.

Gloss finish. For a gloss finish, the last coat is not rubbed at all.

160. Patching.—It frequently happens in rubbing with pumice that the varnish is cut thru so that the bare wood shows. To patch such a spot proceed as follows: (1) Sandpaper the bare place lightly with very fine paper, No. 00, to smooth the grain of the wood raised by the pumice water. (2) If the wood has been stained or filled, color the spot to match the rest of the finish. Apply a little with a cloth and wipe off clean. (3) When this has dried, carefully apply a thin coat of varnish to the bare wood. Draw it out beyond the bare wood a little, "feathering" it so that there shall not be a ridge. (4) Allow this to dry hard and apply a second coat, feathering it beyond the surface covered by the first coat. (5) Repeat until the required thickness has been obtained; then

(6) rub with pumice and water. Rub lightly, using a little pumice and much water. The slightly raised rings made by the lapping of one coat upon another will need special attention. It is best not to sandpaper between coats, because of the danger of scratching the rubbed finish adjoining the patch.

161. Painting.—The purpose of paints is to preserve the wood by covering it with an opaque material. Paints are usually composed of white lead or zinc oxide and coloring materials mixed or thinned with raw or boiled linseed oil. Turpentine is also used for thinning and as a drying agent.

Paint must be well brushed out so that a thin film may result.

In painting, (1) Cover the knots with shellac, or the oil of the paint will be absorbed thru two or three coats and discoloration result. (2) Put on a prime coat. This coat should be mixed as thin as it can be and still not "run" when applied to vertical surfaces. (3) Fill the nail holes with putty. Sand lightly if a smooth finish is desired. (4) Apply two or three coats of paint thin enough to flow freely but thick enough to cover well and not "run."

The second coat is given a little more than the usual amount of turpentine that a "flat effect" may prepare the way for the final gloss coat. If the last coat is to be dull, turpentine is used in it as well as the second. Oil causes gloss, turpentine causes a dull or flat effect.

APPENDIX

ADDITIONAL JOINTS.

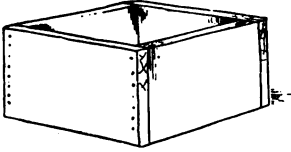

Butt Joint

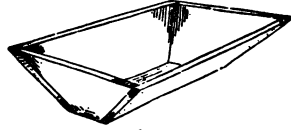

Hopper Joint.

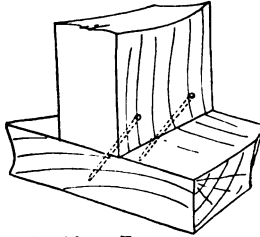

Toe Nail Joint

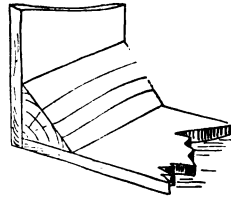

Glued and Blocked Joint



Doweled Butt Joint

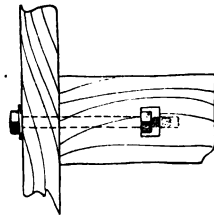

Draw Bolt Joint

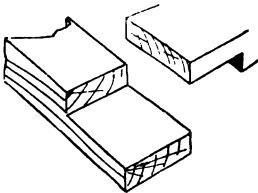

End Lap Joint.

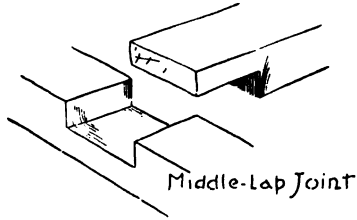

Middle-Lap Joint

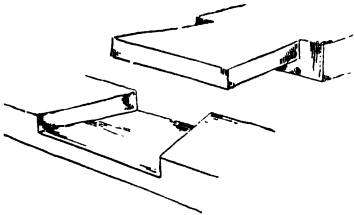

Lapped Dove-tail Joint.

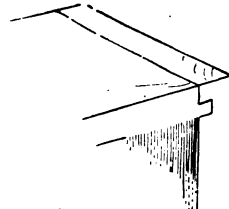

Ledge or Rabbet.

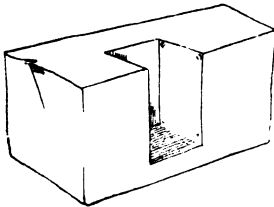

Gained Joint.

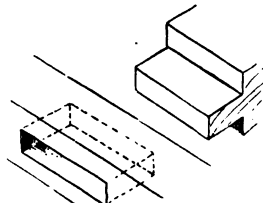

Through Mortise & Tenon

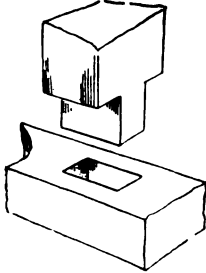

Stub Mortise & Tenon.

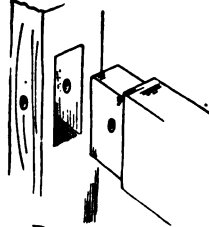

Pinned Mortise & Tenon.

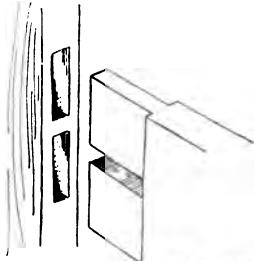

Double Mortise and Tenon

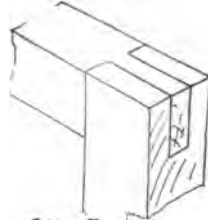

Slip Joint.

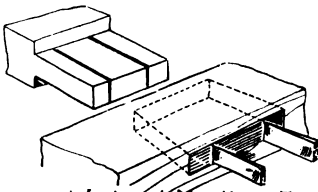

Wedged Mortise & Tenon

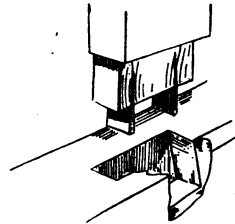

Fox Tail Tenon.

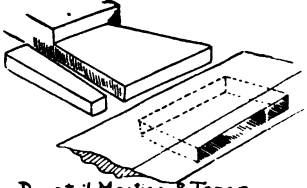

Dovetail Mortise & Tenon

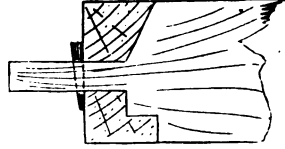

Tusk Tenon

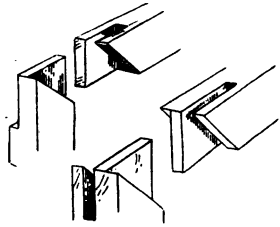

Stretcher Joint.

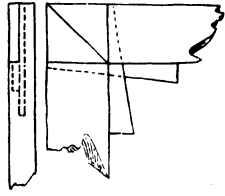

Stretcher Joint.

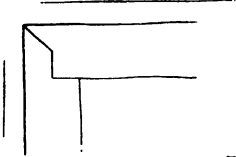

Ledge and Miter Joint

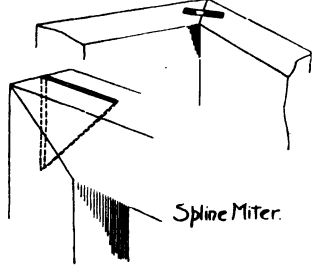

Spline Miter.

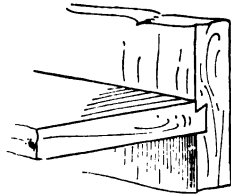

Dovetail Dado.

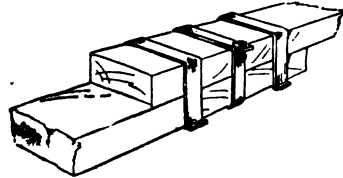

Lapped & Strapped Joint

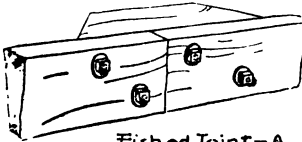

Fished Joint.-A.

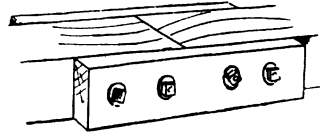

Fished Joint.-B

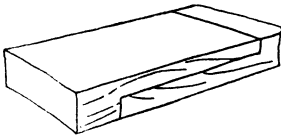

Splice Joint.

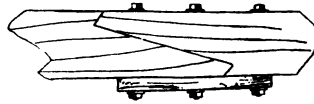

Scarf Joint.

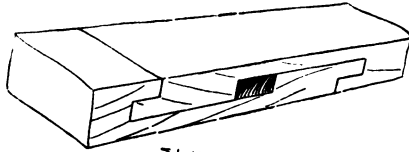

Spliced Joint

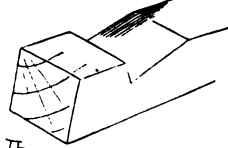

Thrust Joint - A

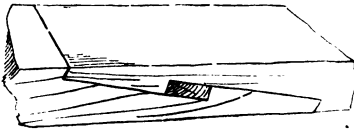

Scarf Joint

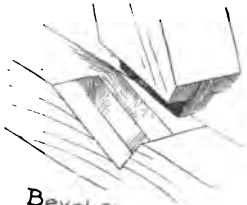

Bevel-Shoulder Joint

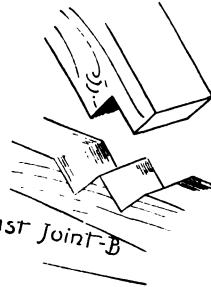

Thrust Joint - B

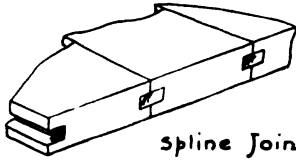

spline Joint.

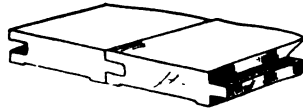

Matched Joint.

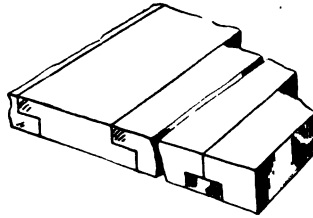

Rabbeted & Filistered Joint

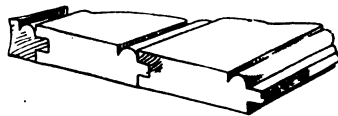

Bedded Joint

APPENDIX II.

WOOD FINISHING RECIPES.

1. Wax.—Cut up beeswax and add to it about one-third of its volume of turpentine. Heat to the boiling point in a double boiler. Or, melt a quantity of beeswax and to this add an equal quantity of turpentine. Care must be taken that the turpentine shall not catch fire.

2. Water Stains.—Any coloring matter that is soluble in water will make a stain.

Mahogany: Three quarts of boiling water, one ounce of Bismarck-brown aniline.

Brown: Extract of logwood, the size of a walnut, dissolved by boiling in four ounces of water. Apply hot and repeat until the desired color is obtained.

Black: First stain the wood brown with the logwood solution. Coat this with a stain prepared as follows: Soak a teaspoonful of cast-iron filings in four ounces of acetic acid or vinegar. Allow it to stand for a week, stirring it occasionally.

Walnut: Make a strong solution of powdered bichromate of potash and hot water. Over this stain apply a coat of the logwood stain.

3. Oil Stains.—Coach colors ground in Japan when thinned with turpentine make good stain. Mix in the proportion of one-half gallon of turpentine to one pound of color and add a little boiled oil. Colors commonly

used are drop-black, Vandyke brown, medium chrome yellow, burnt and raw umber and burnt and raw sienna.

Green: Drop-black, two parts, medium chrome yellow, one part, a little red to kill the brightness.

Walnut: Asphaltum with a little Venetian red.

Golden oak: Asphaltum and turpentine thinned like water, to be followed with filler darkened with burnt umber and black.

* Antique oak: Raw sienna properly thinned, with a little burnt umber and black added.

4. Spirit Stains.

Black: Alcohol and aniline black.

Mahogany: Alcohol and Bismarck brown.

Aniline stains cut with alcohol, and mixed with white shellac and banana oil or amyl alcohol in equal parts, make good stains for small pieces of work.

APPENDIX III.

WORKING DRAWINGS.

A working drawing of an object consists of one or more views of that object so drawn that they make known the size, shape, kind of material, etc.

A working drawing differs from a perspective. The

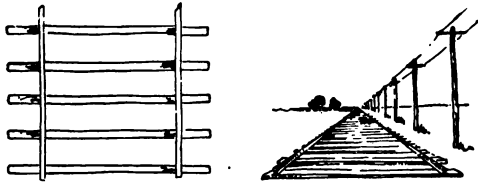

FIG. 1.

former represents an object as it really is, the second represents the object as it appears. Fig. 1.

1. Instruments.—Special instruments are required for

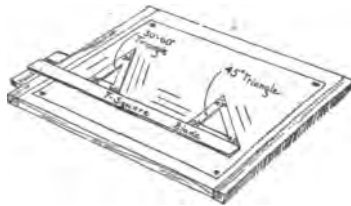

FIG. 2.

the making of a mechanical drawing. Fig. 2 shows a drawing-board with paper fastened to it, also a T-square

and the two triangles. A compass is needed for drawing circles and arcs of circles.

The T-square is used for drawing horizontal lines. The head must be held firmly against the edge of the board and the lines drawn from left to right. Vertical and oblique lines are drawn from the T-square upward, the triangles being held against the edge of the T-square which, at the same time, is held against the edge of the board.

2. Conventions.—Since it would be impossible to make full-sized drawings of some objects—a house for

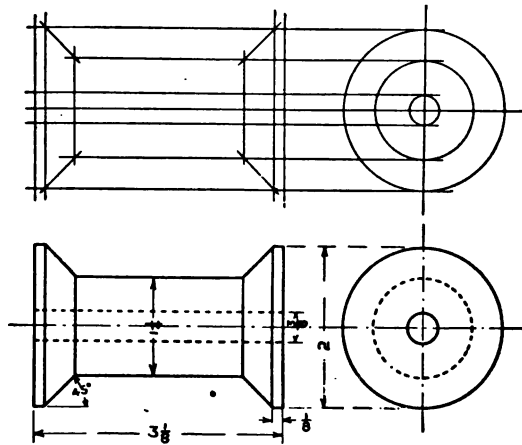
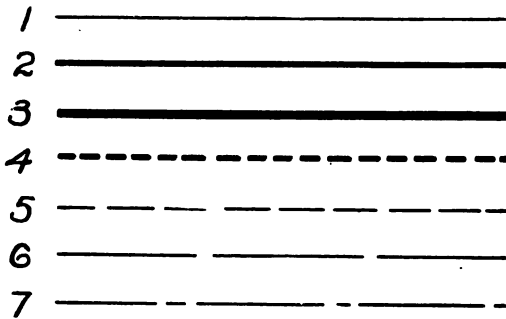

FIG. 3.

instance—it is customary to use a scale and by means of it make a smaller drawing, which shall have all of its parts properly proportioned. For example, if a drawing has printed upon it " $\frac{1}{2}$ inch = 1 inch or 6" = 1'" it means for every inch of the object the drawing is but

one-half an inch. The scale is to be used for measuring only. There is quite a variety of scales. Whatever scale is used, the numbers placed upon the drawing must represent the size of the object and not of the drawing.

In Fig. 3 is shown a mechanical drawing of a common wood spool. It will be seen that there are different kinds of lines. Each has its meaning as follows:



1. Light line—For penciling and cross-hatching.
2. Full line—For visible outlines of objects and limits of parts.
3. Heavy line—For border lines.
4. Dot line—For invisible outlines of objects and limits of invisible parts. Same width as 2.
5. Dash line—For projection lines. Same width as 1.
6. Long dash line—For dimension lines. Same width as 1.
7. Dot-and-dash line—For center lines and section lines. Same width as 1.

When there is not room for the figures that represent dimensions, the arrow-heads may be turned in the direc-

tion of the measurement and placed outside. The figure, too, may be placed outside if necessary.

Nothing but the letters, the figures and the barbs—not the shafts—of the arrow are drawn freehand.

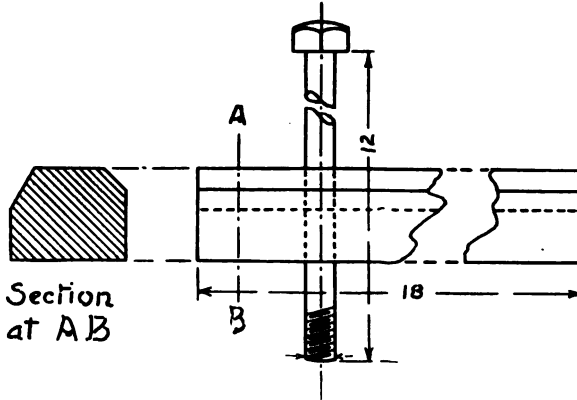

FIG. 5.

FIG. 4.

Sometimes it is desirable to have one dimension shorter than the scale selected would allow; this is done by

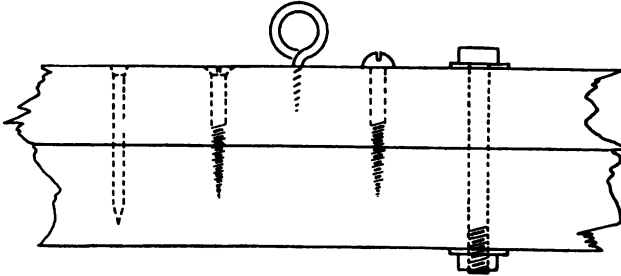

FIG. 6.

means of a broken view: Fig. 4. The figured dimension prevents confusion.

In Fig. 5 is shown a sectional drawing. Sectional drawings represent an object as it would appear if cut,

with the part nearer the worker removed. Sections are indicated by "cross-hatching," the lines being equally spaced and drawn at an angle of 45 degrees.

Screws and nails are represented as in Fig. 6.

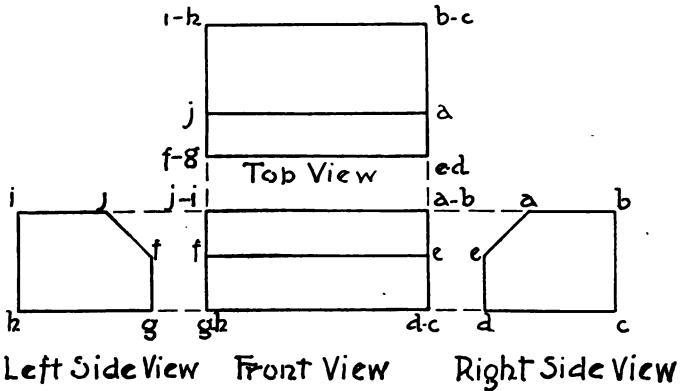

FIG. 7.

3. Projection and Relation of Views.—The names and the relative positions of three views are shown in Fig. 7. From these it will be seen (1) that the different views are arranged with reference to the front view, so that the part of a side view which is nearest the front view represents a part of the front of the object, (2) that the corresponding horizontal measurements of top and front views are alike, (3) that the corresponding vertical measurements of front and side views are alike, (4) that the corresponding vertical measurements of the top view and horizontal measurements of a side view are alike.

4. Letters and Figures.—Letters are usually made freehand, light ruled lines at the top and bottom acting

as guides. A simple style of letter and figure is shown in Fig. 8. They are placed in spaces that the proportion of the parts may the more readily be seen. They may be narrowed or widened by changing the width of the

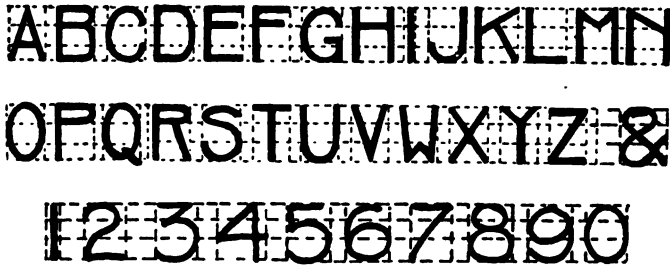

FIG. 8.

spaces, and shortened or lengthened by changing the height of the spaces.

5. Constructions.—The hexagon, or six-sided figure; the octagon, or eight-sided figure; and the ellipse are so very frequently used in simple woodwork, that their construction is given here.

Directions for hexagon, Fig. 9: Describe a circle of a

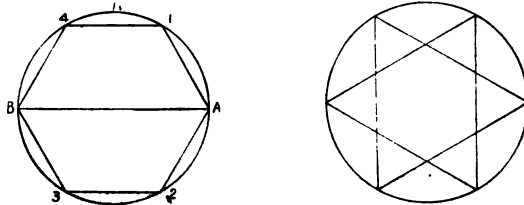

FIG. 9.

size equal to the required distance of hexagon from corner to corner. Draw the diameter A-B. With the point A

as a center, using the radius of the circle, cut the circle at 1 and 2. With B as a center, and the same radius, cut the circle at 3 and 4. Connect A-1, A-2, 2-3, etc. Con-

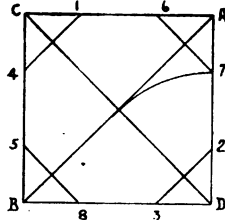

FIG. 10.

necting every other point, as A-3, 2-B, etc., makes a six-pointed star.

Directions for octagon, Fig. 10: Draw a square with a width equal to the desired width of the octagon from side to side. Draw the diagonals. With the points A, B, C, and D as centers and a radius equal to one-half the diagonal, cut the sides of the square at 1, 2, 3, 4, 5, 6, 7, 8. Connect these points as shown.

Directions for ellipse, Fig. 11: An ellipse is a curve

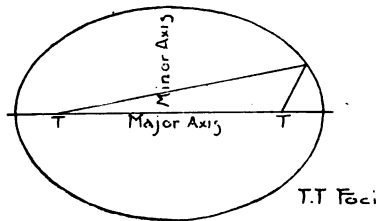

FIG. 11.

such that the sum of the distances from any point on it to two fixed points called the foci shall always be the same.

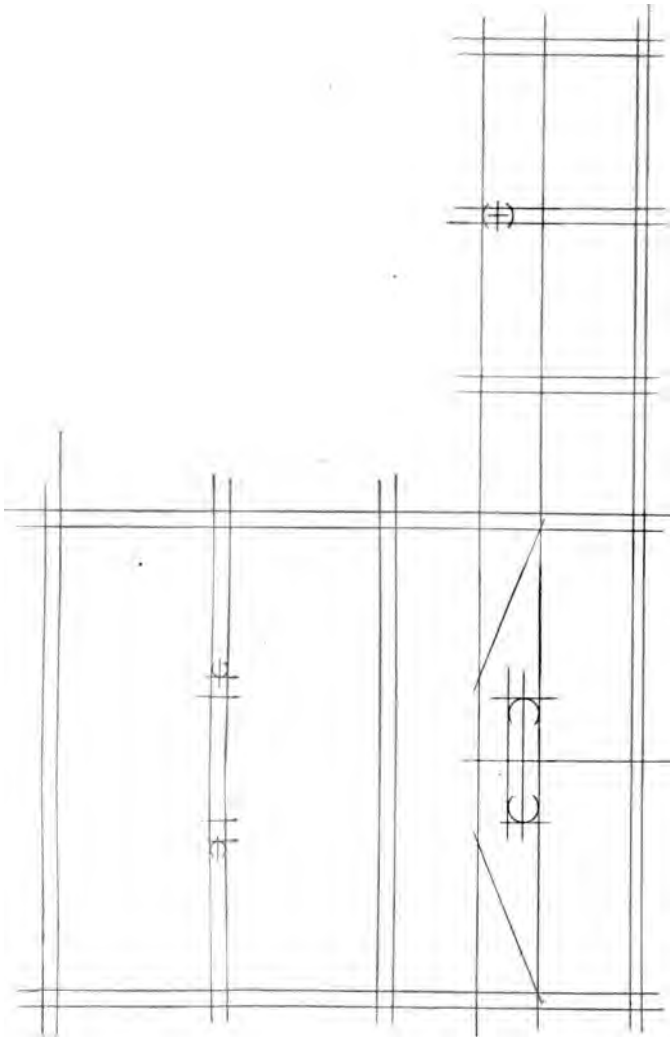

FIG. 12.

An easy way to construct such a curve is to place two thumb tacks at the foci, attach the ends of a string to them. With a pencil moving freely in the string but holding it taut draw the curve. By moving the tacks farther apart or closer together and by lengthening or shortening the string, the size and shape of the curve may be changed as desired.

6. Order of Procedure.—Beginners should strive to know and to acquire good practice in drawing. Before beginning see that the pencil is properly sharpened.

(1) Determine the size and spacings of the views so that the parts of the drawings may be properly placed.

(2) With light full lines block out the different views. Blocking-out lines are made of indefinite length and the proper distances marked off on them after they are drawn. Holding the rule or scale upon the drawing vertically, mark off the vertical spaces. Draw light lines thru these points. Upon one of these horizontal lines lay off the horizontal spaces. Draw light vertical lines thru these points. Fig. 12.

(3) Put on the dimensions.

(4) Put on the lettering.

(5) The drawing is ready for inking. In blocking-out, all lines are made full, light. In inking, the different kinds must be represented properly. Fig. 13. If it is not to be inked go over the lines that represent edges with the pencil a second time so that the outlines of the object will "stand out."

INDEX.

Ability.....	4	Basswood.....	142
Acetic Acid.....	171	Bast.....	117
Additional Joints.....	164	Beaded Joint.....	170
Air Drying.....	135	Beader.....	105
Angiosperms.....	138	Bee tree.....	142
Angles, setting the bevel to angles of 30, 45 and 60 de- grees.....	14	Bench, care of.....	3
Angles of triangles, in draw- ing.....	173	Bench hook.....	44
Aniline.....	171	Bevel, names of parts; its uses.....	13
Aniline stains, recipe for....	172	Bevel; same as chamfer... 45,	68
Annual rings.....	117	Bevel shoulder joint.....	169
Antique oil stain, recipe for..	172	Bichromate of potash.....	171
Appendix I, Additional Joints	164	"Birds' eyes".....	125
Appendix II, Wood finishing recipes.....	171	Bits, center.....	48
Appendix III, Working Draw- ings.....	173	auger.....	48
Arris.....	36	drill.....	49
Arrow Heads, placing of....	175	gimlet.....	49
Asphaltum.....	172	countersink.....	49
Assimilation, tree growth....	119	screwdriver.....	49
Auger bit.....	48	Bitstock.....	47
Autumn Wood.....	119	Black spirit stain, recipe for.	172
Ash.....	141	water stain, recipe for... 171	
Back-saw.....	24	Block-plane.....	34
Bamboos.....	138	Block, sandpaper.....	74
Banana oil stain, recipe for..	172	Blued screws.....	79
Bark.....	116	Board foot.....	137
		Boards.....	130
		Boring, positions while.....	50
		thru.....	52
		to depth.....	52
		Brace.....	47

Brad-awl.....	50	Clamps.....	81
Broad-leaved trees.....	138, 141	Classification of woods.....	138
Broken view.....	176	Clear Lumber.....	137
Brush, directions for using...	152	Cleavability of wood.....	124
Brushes.....	150	Coach colors.....	171
Burners, refuse.....	134	Combination plane.....	105
Burnisher.....	73	Compass.....	174
Butternut.....	143	Compass saw.....	27
Butt joint.....	164	Conifers.....	138
Button wood.....	148	Coniferous woods.....	139
Butts, hinges.....	113	Constructions, geometrical...	178
		Conventions, drawing.....	174
		Copal varnish.....	158, 160
		flowing of.....	160
Cabinet Clamps.....	82	Cortex.....	117
Cambium.....	117	Countersink bit.....	49
Cans, Shellac.....	151	Crosscut saw.....	23
Canter, steam.....	134	Cross-grained.....	124
Cap for plane.....	29, 30	Cross-hatching.....	175
Carbon.....	119, 120	Cross-lap joint.....	88
Carbonic acid gas.....	120	directions for making—	
Carefulness.....	3, 4	first method.....	88
Care of tools and bench.....	3	second method.....	90
Carriage, log.....	132	Cross section of tree.....	116
Case hardening.....	137	Curve sawing.....	26
Cedar.....	139	Curved surfaces and edges,	
Cells.....	118	forming of.....	67
Cell Walls.....	122	Cutting up stock.....	19
Center beader.....	105	Cycadaceae.....	138
Center lines.....	175	Cylinder, making of.....	65
Chamfering with chisel.....	57	Cypress.....	140
Chamfer, planing.....	45		
Checks in lumber.....	123, 137	Dado.....	87
Cheeks of tenon.....	94, 97	directions for making.....	87
Cherry.....	143	Deciduous.....	139
Chestnut.....	144	Dicotyledon.....	138
Chisel, cutting action of.....	54	Digestion of plant food.....	120
boards.....	3	Dimension lines.....	175
Chisels and chiseling.....	53		
classes.....	53		
Chlorophyll.....	119		

- Divide a board into any number of equal parts.... 10
 Dividers, names of parts; uses..... 18
 Dogs, milling..... 132
 Door, fitting a..... 112
 Double mortise-and-tenon... 166
 Dovetail corner, directions for..... 107
 dado..... 168
 joint..... 102
 directions for making. 103
 mortise-and-tenon..... 167
 Doweled butt joint..... 164
 Doweling..... 92
 Dowels, directions for making..... 92
 Draw bolt joint..... 164
 Drawer Construction..... 106
 Drawers, directions for..... 108
 Drawfiling..... 72
 Drawing board..... 173
 Drawings, working..... 173
 Dressed lumber..... 137
 Drill bit..... 49
 Drop black..... 172
 Dull finish..... 162
 Duplicate parts, laying out.. 70
 Duster..... 150

 Edgers..... 134
 Egg-shell gloss, copal varnish..... 161
 Elasticity of wood..... 124
 Ellipse..... 179
 Elm..... 144
 End-lap joint..... 165
 Endogens..... 139
 End planing..... 43, 44

 Evergreens..... 139
 Excelsior..... 156
 Exogens..... 138

 Face marks..... 36
 Face side, face edge..... 36
 Feather edge..... 62, 63
 Feathering chisel cuts..... 114
 Feathering strokes in wood finishing..... 152
 Felling trees..... 127
 Fence for plane..... 105
 Fibers, wood..... 124
 Figures and letters in mechanical drawing..... 177
 Filing saws..... 27
 Fillers..... 154
 Fillet..... 111
 Filletster..... 105
 Filling with paste filler..... 155
 Finger gaging..... 17
 Finish, dull copal varnish... 162
 gloss copal varnish..... 162
 polished copal varnish.. 162
 Finishes, typical, for coarse grained woods..... 161
 wood..... 150
 Fished joints..... 168
 Fitting joints..... 85
 Flare stick..... 103
 Flatted, filler..... 155
 Flowering plants..... 138
 Fore-plane..... 34
 Form work..... 65
 Fox tail tenon..... 166
 Framing square..... 13
 Fruits..... 138
 Fuming..... 157

Gage for wire of nails.....	79	Hand screw.....	81
for wire of screws.....	80	Hardness of wood.....	124
mortise.....	18	Hard pine.....	140
pencil.....	17	Hardwoods.....	139
slitting.....	17	Hardwood, sawing joints in.....	86
the marking.....	15	Haunched mortise-and-tenon.....	110
Gaging, thumb.....	19	Heartwood.....	117
directions for.....	16	Herbs.....	138
Gained joint.....	165	Hexagon.....	178
Gains.....	114	Hickory.....	145
Georgia pine.....	140	High lights in wood finish- ing.....	155
Getting out stock.....	19	Hinging a door.....	113
Gimlet bit.....	49	Hopper joint.....	164
Glass panels.....	111	Hydrogen.....	119
Gloss, egg-shell shellac.....	159		
Glue.....	80	Inking drawings.....	182
Glue joint, directions for making.....	90	Instruments, drawing.....	173
Glued and blocked joint.....	164	Introduction.....	3
Gluing.....	83	Iron filings.....	171
Gnetaceae.....	138		
Golden oak oil stain, recipe.....	172	Jack plane.....	32
Gouge.....	58	Jam, log.....	129
Grain of wood.....	36, 124	Joinery, general directions for.....	84
Green oil stain, recipe.....	172	Joint edge.....	40
Grinding beveled edge tools.....	58	Jointer.....	33
Grindstones.....	59	Joint firs.....	138
Grooves.....	87	Jointing edges.....	90
cutting.....	110	Jointing saw teeth.....	27
Growth, tree.....	119	Joints.....	84-112, 164-170
Gum.....	145		
Gums, copal.....	160	Key, directions for.....	94
Gymnosperms.....	138	Keyed tenon-and-mortise.....	94
		Kiln drying.....	135
Hauling logs to skidway.....	127	Knife in laying out.....	86
Half-blind dovetail.....	106	Knots.....	119
Hammer handle, illustration of modeling.....	68		
Hammers.....	75	Lac.....	159

- Lapped dovetail joint..... 165
 Lapped and strapped joint... 168
 Laps in wood finishing..... 152
 Lath..... 134, 137
 Laying out duplicate parts... 70
 rough stock..... 19
 tools..... 9
 work..... 85
 Ledge and miter joint..... 167
 Ledge or rabbeted joint. 106, 165
 Lenticels..... 121
 Letters and figures..... 177
 Lime tree..... 142
 Linden..... 142
 Lines, kinds in drawing..... 175
 gage..... 16
 horizontal, vertical, ob-
 lique..... 174
 knife..... 19
 pencil..... 19
 Linseed oil..... 160
 Liquidambar..... 145
 Locks..... 115
 Log-boom..... 129
 deck..... 132
 pond..... 131
 Logwood..... 171
 Lumbering..... 126

 Machine planed..... 71
 Mahogany spirit stain, recipe 172
 Mallet..... 53
 Maple..... 146
 Marking gage..... 15
 Matched joint..... 170
 Matching plane..... 105
 Measure, face, lineal, board. 137
 Measurements, consecutive.. 9
 lumber..... 137

 Mechanical drawing..... 173
 Medulla..... 116
 Middle, to find the middle of
 edge or surface..... 10
 Middle-lap joint..... 165
 Milling..... 129
 Mill-marks..... 72
 Mill planed..... 45, 71
 Miter joint..... 101
 directions for making... 102
 Modeling..... 68
 Moisture..... 122
 Monocotyledons..... 138
 Mortise, directions for..... 97
 gage..... 18
 in tenon, directions for.. 97
 -and-tenon, blind..... 97
 directions for laying out. 98
 directions for cutting,
 first and second meth-
 od..... 99, 100
 Mullion, door..... 112

 Nailset..... 77
 Nailing..... 77
 Nails..... 75
 withdrawing..... 78
 Naked seeds..... 138
 Nitrogen..... 119

 Oaks, white, red, live..... 147
 Octagon..... 179
 Octagonal prism..... 65
 Oil or copal varnish..... 160
 Oilstones..... 60
 Oily waste..... 4
 One-seed-leaf..... 138
 Order of procedure in draw-
 ing..... 182

Orderliness.....	3, 4	Planing first end.....	43
Oxygen.....	119	second end.....	43
		rules for.....	44
		chamfers.....	45
Painting.....	163	Planing, machine.....	71
Palms.....	138	Planks.....	130
Palm ferns.....	138	"Play" in fitting doors.....	113
Panel gage.....	17	Plow.....	105
Paneling.....	109	Points per inch of saw teeth.....	21
Paring chamfers.....	57	Poplar, yellow.....	148
horizontal.....	55	Preface.....	1
oblique and curved line.....	57	Prices, basis of lumber.....	137
vertical.....	56	Properties, other, of wood.....	124
Patching finishes.....	162	Projection, drawing.....	177
Patience.....	3	Pumice stone.....	162
Pencil gage.....	17	Putty.....	111
in laying out.....	86		
lines, when used, how		Quarter sawing.....	134
removed.....	19		
Penny, size of nails.....	76	Rabbeted corner, directions	
Perspective drawing.....	173	for.....	106
Phanerogamia.....	138	and fillistered joint.....	170
Pickets.....	134	Rabbeting.....	111
Pine.....	140	plane.....	105
Pines.....	138	Rafts.....	129
Pinned mortise-and-tenon.....	166	Rail of door.....	112
Pith.....	116	Rake of saw teeth..... 21, 24, 28	28
Pitch of saw teeth..... 21, 24,	28	Ratchet brace.....	47
Plane-iron or blade.....	29	Rays, medullary.....	118
adjustment of..... 31, 35	35	Recipes, wood finishing.....	171
setting of..... 30, 35	35	Respiration.....	121
Plane-irons for manual train-		Rip-saw.....	24
ing schools.....	33	River-driving.....	129
Plane parts.....	30	Rolls, "live".....	134
Planes.....	29	"Roughing off".....	38
wooden.....	34	Rubbed finishes.....	162
Planing first surface true.....	39	Rubbed glue joints.....	83
first edge.....	41	Rule, the.....	9
second edge.....	42		
second side.....	42		

Salts, mineral.....	119	Shellac, white, orange.....	159
Sandpaper.....	74	finishes.....	159
Sandpapering.....	73	Shingles.....	134, 137
Sap.....	119	Shoulders of tenon.....	94, 97
Sapwood.....	117	Shrinkage.....	122
Saw-butting.....	134	Side jointing of saw teeth... ..	28
Sawing.....	22, 24, 25	Sienna.....	172
Saw, jump.....	134	Sized or surfaced lumber... ..	137
Sawmill.....	130, 132	Skidding.....	127
Saws, names of parts; construction, uses.....	21	Slab.....	132
circular, band, gang....	130	Slasher.....	134
Saw-set.....	27	Slide, log.....	130, 133
Scale, drawing.....	174	Slip joint.....	166
Scarf joint.....	168, 169	Slip stone.....	63
Scrapers.....	71	Slitting gage.....	17
Scraping.....	71	Smooth plane.....	33
Screws.....	78	Smoothing surfaces.....	71
Screws, fastening with.....	79	Soft pine.....	140
Screwdriver.....	78	Soft wood, working of.....	86
Screwdriver bit.....	49	woods.....	139
Seasoning lumber.. ..	135	Spiral screwdrivers.....	50
Sectional drawing.....	176	Spirit varnish.....	158
Section lines.....	175	Splash dam.....	129
of tree.....	116	Splice joint.....	168, 169
Set of saw teeth.....	21, 27	Spline joint.....	170
Setting the dividers.....	18	miter.....	167
the gage.....	15	Spokeshave.....	67
Shape of cutting edge of plane-iron.....	32, 33, 34	Spontaneous combustion... ..	156
Sharp, to tell whether a tool is.....	63	Spruce.....	141
Sharpening auger bit, caution about.....	48	Squaring lines across a piece. .	11
chisel.....	61	S-2-S.....	137
gouge.....	63	Stains.....	156
plane-iron.....	63	oil, recipe.....	171
scrapers.....	73	spirit, recipe.....	172
Sharp tools, necessity for....	3	water, recipe.....	171
		Sticking lumber.....	136
		Stile of door.....	112
		Straight-edge.....	19
		Strop.....	62

Strength of wood.....	124	Turning saw.....	26
Stretcher joint.....	167	Turpentine.....	160
Stub mortise-and-tenon.....	166	Tusk tenon.....	167
Summer wood.....	120	Two-seed-leaf.....	138
Superposition.....	85		
Sycamore.....	148	Umber.....	172
System in laying out.....	85	Unit of measure, lumber.....	137
		in woodwork.....	9
Tables, board measure, raft- er and brace.....	13	Vandyke brown.....	172
Tails of dovetail.....	102	Varnishes.....	158
Tangential section of tree.....	116	Venetian red.....	172
Tenon, directions for.....	94, 98	Views, relation of, in draw- ing.....	177
Terms, lumber.....	137		
Testing edges or ends for squareness.....	12	Walnut.....	149
with try-square for width or thickness.....	13	oil stain, recipe.....	172
Thru mortise-and-tenon.....	165	water stain, recipe.....	171
Thrust joint.....	169	Warpage.....	123
Thumb gaging.....	19	Waste in sawmills.....	134
Timbers.....	130	Water beech.....	148
Tissue.....	116	Wax, recipe.....	171
Toe nail joint.....	164	Waxing.....	157
Toughness of wood.....	124	Wedged mortise-and-tenon..	166
Tracing, wood-finishing.....	153	Weight of wood substance... 123	
Transpiration.....	121	White walnut.....	143
Transportation, lumber.....	135	Whetting beveled edge tools.	60
Transverse section of tree ..	116	Wind.....	37, 39
Trestles.....	22	Winding sticks.....	40
Triangles.....	174	Wire edge.....	62
Trimmer, saw milling.....	134	Wood structure.....	116
Try-square.....	10	Woods, common.....	138
T-square.....	173	Working drawings.....	173
Tulip wood.....	148	Working face.....	36

Books on the Manual Arts

DESIGN AND CONSTRUCTION IN WOOD. By Noyes.

A book full of charm and distinction. It illustrates a series of well designed and attractive projects and gives suggestions for other similar projects, all suitable for home use, together with information regarding tools and processes for making. A pleasing volume abundantly and beautifully illustrated. \$1.50.

HANDWORK IN WOOD. By Noyes.

A comprehensive and scholarly treatise, covering logging, saw-milling, seasoning and measuring, hand tools, wood fastenings, equipment and care of the shop, the common joints, types of wood structures, principles of joinery, and wood finishing. 304 illustrations—excellent pen drawings and many photographs. The best reference book available for teachers of woodworking. \$2.00.

WOOD AND FOREST. By Noyes.

A reference book for teachers of woodworking. Treats of wood, distribution of American forests, life of the forest, enemies of the forest, destruction, conservation and uses of the forest, with a key to the common woods by Filibert Roth. Describes 67 principal species of wood with maps of the habitat, leaf drawings, life size photographs and microphotographs of sections. Profusely illustrated. \$3.00.

CARPENTRY. By Griffith.

A well illustrated textbook for use in vocational schools, trade schools technical schools, and by apprentices to the trade presenting the principles of house framing in a clear and fundamental way. An admirable combination of practical experience and constructive principles.

WOODWORK FOR SECONDARY SCHOOLS. By Griffith.

A textbook for high schools, colleges, and technical schools. It contains chapters on woods, tools and processes, joinery, turning, carving, inlaying, wood finishing, pattern making, and the use of woodworking machines. It is a well balanced and authoritative text, presupposing a knowledge of elementary tool processes. Specially adapted to secondary schools.

CORRELATED COURSES IN WOODWORK AND MECHANICAL DRAWING. By Griffith.

Contains reliable information concerning organization of courses, subject matter, and methods of teaching. It covers classification and arrangement of tool operations, stock bills, cost of material, records, shop conduct, the lesson, maintenance, equipment and lesson outlines for grammar and high schools. The most complete and thoro treatment of the subject of teaching woodworking ever published. \$1.50.

BEGINNING WOODWORK. By Van Deusen.

A valuable textbook for rural schools, by one who has made a special study of the manual training problems in the country school. A full and clear description in detail of the fundamental processes of elementary benchwork in wood. \$1.00.

PROJECTS FOR BEGINNING WOODWORK AND MECHANICAL DRAWING. By Griffith.

A collection of 50 working drawings and working directions of projects which have proven of exceptional service where woodworking and mechanical drawing are taught in a thoro, systematic manner in the seventh and eighth grades. 75 cts.

ADVANCED PROJECTS IN WOODWORK—FURNITURE MAKING. By Griffith.

A collection of problems in furniture making selected and designed with reference to high school use. On the plate with each working drawing is a good perspective sketch of the completed object. In draftsmanship and refinement of design these problems are of superior quality. An excellent collection. \$1.00.

FURNITURE DESIGN FOR SCHOOLS AND SHOPS. By Crawshaw.

A manual on furniture design containing a collection of plates showing perspective drawings of typical designs, representing particular types of furniture. Each perspective is accompanied by suggestions for rearrangements and the modeling of parts. The text discusses and illustrates principles of design as applied to furniture. Should be in the hands of every teacher of cabinet making and designing. \$1.00.

PROBLEMS IN FURNITURE MAKING. By Crawshaw.

Contains 43 full-page working drawings of articles of furniture. In addition to the working drawings there is a perspective sketch of each article completed. There are 30 pages of text giving notes on the construction of each project; chapters on the "Design," and "Construction" of furniture, and one on "Finishes." The last chapter describes 15 methods of wood finishing, all adapted for use on furniture. \$1.00.

PROBLEMS IN WOODWORKING. By Murray.

A collection of 40 plates of working drawings of problems in bench work that have been successfully worked out by boys in grades seven to nine, inclusive. 75 cents.

PROBLEMS IN WOOD-TURNING. By Crawshaw.

Contains 25 full-page plates of working drawings covering spindle, faceplate, and chuck turning. It gives the mathematical basis for the cuts used in turning. A valuable textbook for students' use. 80 cents.

WORKSHOP NOTE-BOOK—WOODWORKING. By Greene.

A note-book which furnishes a few general and extremely important directions about tools and processes; and provides space for additional notes and working drawings. It is essentially a collection of helps, ideas, hints, suggestions, questions, facts, illustrations, etc. It is full of suggestions, shows a keen insight into subject matter and teaching methods and is an effective teaching tool. 15 cents.

PROBLEMS IN MECHANICAL DRAWING. By Bennett.

A students' textbook consisting of 80 plates of problems classified into groups according to principle, and arranged according to difficulty of solution. Each problem is given unsolved and therefore in proper form to hand to the pupil for solution. The best collection of problems for first year high school students available. \$1.00.

MANUAL TRAINING TOYS FOR THE BOYS' WORKSHOP. By Moore.

A popular boys' book. It contains 35 pages of full-page plates of working drawings illustrating 42 projects. All the projects are overflowing with "boy" interest, and are well adapted to the upper grades of the elementary school. The text treats of tools and tool processes and gives instructions for making each project. \$1.00.

KITECRAFT AND KITE TOURNAMENTS. By Miller.

Authoritative and comprehensive. The book deals with the construction and flying of all kinds of kites, and the making and using of kite accessories. Also aeroplanes, gliders, propellers, motors, etc. Abundantly illustrated and attractively bound. \$1.00.

PRACTICAL TYPOGRAPHY. By McClellan.

A textbook for students of printing containing a course of exercises ready to place in the hands of pupils. It explains and illustrates the most approved methods used in correct composition. It contains 63 exercises treating of composition from "Correct Spacing" to the "Making up of a Book," and the "Composition of Tables." \$1.50.

ART METALWORK. By Payne.

A textbook written by an expert craftsman and experienced teacher. It treats of the various materials and their production, ores, alloys, commercial forms, etc.; of tools and equipments suitable for the work, the inexpensive equipment of the practical craftsman; and of the correlation of art metalwork with design and other school subjects. It is abundantly and beautifully illustrated. The standard book on the subject. \$1.50.

LEATHER WORK. By Mickel.

A manual on art leather work for students, teachers and craft workers. It gives detailed descriptions of the various processes of working, treating of flat modeling, embossing or repousse, carved leather and cut work. It is well illustrated with photographs of finished work and working drawings of 20 useful and beautiful articles suitable for school and home work. 75 cents.

BOOKS ON THE MANUAL ARTS.

A bibliography listing and describing 400 books, mailed free.

Published by **The Manual Arts Press** *Peoria, Ill.*

